



Historic Bridge Management Plan for the Old Mississippi River (Huey P. Long) Bridge

Recall Number: 051880

Structure Number: 61170071000001

Parish: East Baton Rouge and West Baton Rouge

Route: US 190

Crossing Description: Mississippi River



Prepared for

**Louisiana Department of
Transportation and
Development**

Prepared by

**Mead
& Hunt**

www.meadhunt.com

March 2017

THIS PAGE INTENTIONALLY LEFT BLANK

Table of Contents

	Page
Executive Summary	1
1. Introduction	3
2. Location Map	5
3. Historic Data	7
A. Identifying information	7
B. Description of bridge	7
C. History and significance	11
D. Character-defining features	13
4. Engineering Data.....	19
A. Existing conditions	19
(1) Structural observations	19
(2) Non-structural observations	22
(3) Serviceability observations.....	22
B. Sources of information.....	22
5. Recommendations	39
A. Preventative maintenance	39
B. Rehabilitation	40
C. Identification of any anticipated design exceptions	40

Appendices

- A Historic Inventory Form
- B Select Plan Sheets
- C Maintenance Responsibility Exhibit

THIS PAGE INTENTIONALLY LEFT BLANK

Executive Summary

The Old Mississippi River Bridge (Recall No. 051880) is located in East Baton Rouge and West Baton Rouge Parishes, Louisiana, and is owned by the State of Louisiana. Construction of the bridge was completed in 1940. The bridge was significantly rehabilitated in 1986-1987, and again beginning in 2012. The bridge was determined eligible for the National Register of Historic Places (National Register) prior to 2013. It is significant as an important example of a distinctive type of truss bridge; specifically, it features a continuous Warren through truss with cantilever construction used in the main spans. Additionally, the bridge was engineered to carry both train and vehicular traffic by using cantilevered construction to suspend the roadways laterally from the main truss spans. The use of caissons during substructure construction was also a noteworthy achievement.

The bridge carries four lanes of U.S. Highway (US) 190 and one track of the Kansas City Southern Railroad across the Mississippi River in Baton Rouge, Louisiana. The total length of the bridge is approximately 12,313 feet. The length of the highway portion of the bridge is approximately 5,879 feet. The bridge's main truss spans consist of a five-span, steel, continuous and cantilevered through truss, with two 490-foot-long Warren trusses as the anchor spans at each end, two 848-foot-long cantilevered Warren truss spans that each include a 396-foot-long suspended span, and one central 650-foot-long Warren truss anchor span. Pin-hinged joints are located at the connection between the cantilever truss spans and the suspended spans. Steel plate girder approach spans for both the railroad and highway portions of the bridge are to the east and west of the main truss spans. This bridge is classified as a fracture critical bridge due to the configuration of the truss spans with two truss panels and floorbeams. It is also classified as fracture critical due to the approach spans (highway and rail) on each side of the truss, which represent a two-girder system with a single transverse steel plate girder functioning as the top member of the braced steel tower bents.

This bridge is in satisfactory condition overall, has no major deficiencies, and appears to adequately serve its purpose of carrying vehicular and railroad traffic. The bridge is being rehabilitated in two phases. Phase 1, begun in 2012 and expected to be completed in 2016, consists of repairing, cleaning, and painting steel components of the main truss, highway approach spans, and some railroad approach spans. Phase 2, begun in 2014, consists of repairing, cleaning, and painting of the remaining railroad approach spans. With proper maintenance and rehabilitation, the Old Mississippi River Bridge can continue to serve in its present capacity for 20 years or longer.

Any work on the bridge should proceed according to recommendations in this Historic Bridge Management Plan (Plan), which adhere to the *Secretary of the Interior's Standards for the Treatment of Historic Properties* (Secretary's Standards), the *Management Plan for Historic Bridges Statewide* (Statewide Historic Bridge Plan), and the *Programmatic Agreement among the Federal Highway Administration, the Louisiana Department of Transportation And Development, the Advisory Council on Historic Preservation, and the Louisiana State Historic Preservation Officer Regarding Management of Historic Bridges in Louisiana* (PA).

THIS PAGE INTENTIONALLY LEFT BLANK

1. Introduction

This Plan, used in conjunction with the Statewide Historic Bridge Plan, provides guidance on the approach to preservation activities for the Old Mississippi River Bridge (Recall No. 051880), identified as a Preservation Priority Bridge. Completion of individual management plans for Preservation Priority Bridges and the Statewide Historic Bridge Plan fulfills terms of the PA, which was executed on September 21, 2015.

The PA provides the basis and procedures for the management of historic bridges in Louisiana and outlines the procedures for the treatment of historic bridges, including Preservation Priority Bridges. In accordance with the PA, an owner seeking state or federal funding for Preservation Priority Bridges will be required by the Louisiana Department of Transportation and Development (LADOTD), in cooperation with the Louisiana State Historic Preservation Office (LASHPO) and the Federal Highway Administration (FHWA), to follow the procedures outlined in this Plan and the Statewide Historic Bridge Plan.

The Statewide Historic Bridge Plan outlines the overall approach to bridge preservation through a discussion of the collaboration of the historian and engineer, guidance on assessing preservation needs, and resources and technical guidance on maintenance and rehabilitation activities that are broadly applicable to historic bridges. A glossary of common engineering and historical terms is included in the Statewide Historic Bridge Plan.

This Plan for the Old Mississippi River Bridge compiles and summarizes the specific historic and engineering information for this Preservation Priority Bridge. It documents the existing use and condition of the bridge, along with assessments of the preservation needs, including cost estimates. Preservation can be accomplished in two manners: preventative maintenance and rehabilitation. Maintenance includes cyclical or condition-based activities that, along with regular structural inspections, are directed toward continued structure serviceability. Rehabilitation activities are near- or long-term steps that need to be taken to preserve and in some cases restore a bridge's structural condition and serviceability. In assessing preservation activities for each Preservation Priority Bridge, a design life of 20 years was considered, which is consistent with the duration of the PA. This Plan provides the bridge owner, and other interested parties, with detailed information related to the historic nature of the bridge and the necessary background to make an informed planning decision. Recommendations within this Plan should be reviewed in 10 years following completion of the Plan to identify any needed updates or revisions.

Existing bridge data sources typically available for Louisiana bridges were gathered for this Plan, and field investigation confirmed the general structural condition and character-defining features of the subject bridge. These sources include:

- The current LADOTD Bridge Inspection Report, and any other similar inspection reports
- Original bridge construction plans, any rehabilitation plans, and record as-built plans, as available
- Existing historical and documentary material related to the historic bridges

Recommendations within this Plan are consistent with the Secretary's Standards. The Secretary's Standards are basic principles created to help preserve the distinct character of a historic property and its site, while allowing for reasonable change to meet new engineering standards and codes. The Secretary's Standards recommend repairing, rather than replacing, deteriorated features whenever possible. A version of the Secretary's Standards that is specific to historic bridges is included in the Statewide Historic Bridge Plan. Following these standards is a requirement of the PA.

A bridge historian and bridge engineer from Mead & Hunt, Inc. (Mead & Hunt) jointly prepared this Plan under contract to the LADOTD. The LADOTD, FHWA, and LASHPO reviewed and provided input into the final Plan.

2. Location Map



0 1,250 2,500 5,000 Feet

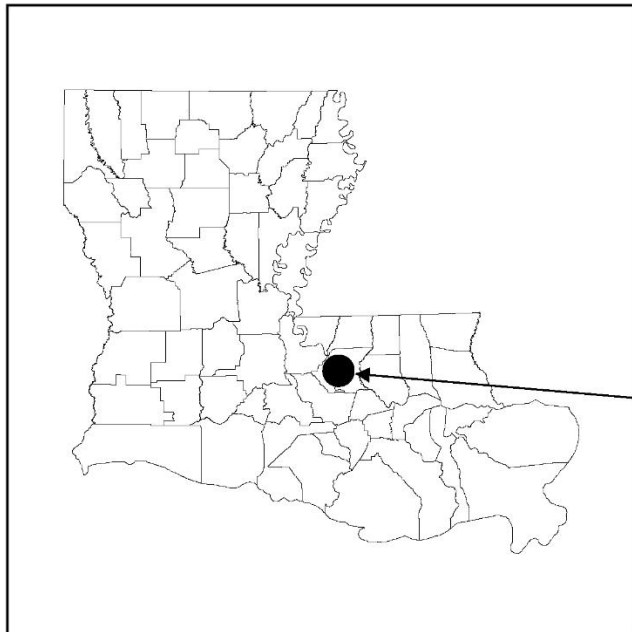

PROJECT LOCATION
Bridge Number: 051880
Structure Number: 61170071000001
East Baton Rouge Parish
Route: US 190
Crossing Description: Mississippi River

THIS PAGE INTENTIONALLY LEFT BLANK

3. Historic Data

A. Identifying information

Structure Number: 61170071000001

Recall Number: 051880

LASHPO Number: 17-01653

Bridge Name: Old Mississippi River Bridge

Date of Construction: 1940; rehabilitated in 1986-1987 and 2012-2016 (Phases 1 and 2)

Main Span Type: Through Truss (Warren Truss)

Contractor: Kansas City Bridge Company, Kansas City, Missouri
Uvalde Construction Company, Dallas, Texas
Bethlehem Steel Company, Bethlehem, Pennsylvania

Designer/Engineer: Norman E. Lant, Louisiana Highway Commission

B. Description of bridge

The Old Mississippi River Bridge is also known as the Huey P. Long Bridge or Huey P. Long - O.K. Allen Bridge after two former Louisiana governors.¹ It is commonly referred to as the Airline Highway Bridge after the local name for US 190. The bridge was completed in 1940 and is located on the northwest side of Baton Rouge, crossing the Mississippi River between East Baton Rouge and West Baton Rouge Parishes. It carries four roadway lanes of US 190, consisting of two lanes in each direction, plus one track of the Kansas City Southern Railroad in the center of the bridge, over the Mississippi River. On the west side of the river, the bridge crosses over Louisiana Highway (LA) 1, a service road, and LA 986, also called River Road. On the east side of the river, the bridge crosses over several private and local streets and the Canadian National Railroad (CNRR).

The total length of this bridge is approximately 12,313 feet, which includes the railroad approaches at each end of the main truss span.² The State of Louisiana owns the bridge.

¹ Legally the bridge is no longer the Huey P. Long Bridge since the Constitutional Amendment that named the bridge after Long was repealed in 1971. However, it is still referred to by this name and a sign with this name is posted on the approach to the bridge.

² Bridge measurements are from 2011 rehabilitation plans. Measurements for a few spans vary slightly on other plan sets. The LADOTD's Master Structure File database only lists the length of the highway portion because this is the only portion of the bridge subject to the Federal Highway Administration's National Bridge Inventory.

Highway spans

The total length of the highway portion of this bridge is approximately 5,879 feet, which encompasses a 3,326-foot, five-span, continuous and cantilevered Warren through truss that stretches across the Mississippi River, as well as approach spans to the east and west. From east to west, the bridge spans for the highway portion of the bridge are as follows:

Highway bridge – Easterly approach spans 1 through 13

Span 1 is a steel plate girder span that measures 74 feet, 5.2 inches. Spans 2 through 12 consist of five steel plate girder spans that measure 83 feet, 3.5 inches each, and six steel plate girder spans that measure 43 feet each. Span 13 is a steel plate girder span measuring 84 feet, 9.5 inches.³ The total length of the easterly approach spans is 834 feet, 8 inches from the east abutment to Pier 1.

Highway bridge – Main truss spans 14 through 18 over the Mississippi River:

The five main, steel, continuous and cantilevered through truss spans, which consist of spans 14 through 18, measure 3,326 feet in total and carry the Old Mississippi River Bridge across the Mississippi River. In this continuous span design, the superstructure spans uninterrupted over intermediate supports. The bridge's main truss spans consist of a five-span, steel, cantilever through truss, with two 490-foot-long Warren trusses as the anchor spans at each end (spans 14 and 18), two 848-foot-long cantilevered Warren truss spans that each include a 396-foot-long suspended span (spans 15 and 17), and one central, 650-foot-long, Warren truss anchor span (span 16). Pin-hinged joints are located at the connection between the main cantilever truss spans and the suspended spans. The centerline to centerline spacing of the trusses is 32 feet.

The upper and lower chords and some diagonal members are made of built-up steel members consisting of four plates riveted to form a box with interior diaphragms as stiffeners. Each plate is perforated with oval holes to facilitate the construction of the truss, and to lighten the weight of the bridge. Other diagonal members are comprised of two steel members riveted with latticed plates to form a box-shaped member. Some vertical members are I-shaped steel members, while others are two steel members riveted with latticed plates to form a box-shaped member. These primary members connect at gusset plates with riveted and high-strength bolted connectors.

Highway bridge – Westerly approach spans 19 through 45

Span 19 is a steel plate girder span totaling 84 feet, 9.5 inches.⁴ Spans 20 through 44 consist of 12 steel plate girder spans that measure 83 feet, 3.5 inches each, and 13 steel plate girder spans that measure 43 feet each. Span 45 is a steel plate girder span measuring 74 feet, 5.2 inches. The total length of the westerly approach spans is 1,718 feet, 8.4 inches as measured from Pier 6 to the west abutment.

³ There is an additional 1 foot from the centerline pier to the centerline bearing of the truss span.

⁴ There is an additional 1 foot from the centerline pier to the centerline bearing of the truss span.

Railroad spans

The total length of the railroad portion of this bridge is approximately 12,313 feet. The 3,326-foot, five-span, continuous and cantilevered Warren through truss carries both the highway and railroad portions of the bridge, so the measurements of those spans are identical. The east and west approach spans, however, differ significantly from the highway bridge. From east to west, they are as follows:

Railroad bridge – Easterly approach spans 1 through 57

Spans 1 and 2 are steel plate girder spans that each measure 43 feet. Span 3 is an 88-foot steel plate girder span. Spans 4 through 56 consist of 26 steel plate girder spans that each measure 83 feet, 3.5 inches, and 27 steel plate girder spans that each measure 43 feet. Span 57 is a steel plate girder span that is 84 feet, 9.5 inches long. The total length of the easterly approach spans is 3,585 feet, 4.5 inches. Spans 45 through 57 are contiguous with the highway portion of the bridge, beginning at braced steel tower Bents 45 and 46.

Railroad bridge – Main truss spans 58 through 62 over the Mississippi River

See above description for main truss spans 14 through 18 of the highway portion of the bridge. The total length of the truss spans is 3,326 feet.

Railroad bridge – Westerly approach spans 63 through 147

Span 63 is an 84-foot-9.5-inch-long steel plate girder span. Spans 64 through 106 consist of 22 steel plate girder spans each measuring 43 feet long, and 21 steel plate girder spans each measuring 83 feet, 3.5 inches long. Spans 107 through 110 consist of two steel plate girder spans of 48 feet and two steel plate girder spans of 83 feet, 1.5 inches. Spans 111 through 126 consist of eight 48-foot-long, welded, steel plate girder spans, and eight 80-foot-long, welded, steel plate girder spans. Span 127 is an 88-foot-long welded steel plate girder span. Spans 128 through 147 consist of 11 welded, steel, plate girder spans each measuring 48 feet long and nine steel plate girder spans each measuring 80 feet long. The total length of the westerly approach spans is 5,402 feet, 2 inches. Spans 63 through 89 are contiguous with the highway portion of the bridge, beginning at braced steel tower Bents 57 and 58.

General bridge information

On the approach spans, the roadway segments and the railroad segments are supported on either individual or combined braced steel tower bents. The individual tower bents support the railroad track approach spans and the end spans of the highway approach spans where the height is the shortest. Other tower bents support both segments of the highway and railroad approach spans as a combination substructure unit. These consist of horizontal steel girders that support the superstructure girders at the top of the tower bents. The horizontal girders are supported by braced steel columns, which bear on cast-in-place concrete pedestals. The pedestals are supported on cast-in-place concrete footings that are supported on 14-inch square or 16-inch square precast concrete pilings. On the truss spans, the roadway segments are cantilevered laterally from the outside of the trusses. The railroad is located in the middle of the trusses. These spans are supported on cast-in-place, reinforced-concrete piers, which are

supported on concrete footings. The footings for the concrete piers 1, 2, 3, 4, and 5 are supported on seal concrete constructed in caissons, which are large, watertight casings used to construct pier foundations below water level. The footing for concrete pier 6 is supported on untreated timber pilings.

The clear roadway width for each direction of highway traffic is 24 feet for two lanes of traffic. A single railroad track is located between the roadways. Steel barrier railings with a picket-type configuration and tubular tri-beam guardrails are located on the outside edges of the bridge. The cast-in-place, reinforced-concrete deck on the approach spans was made composite with the steel plate girders during the 1986-1987 rehabilitation. The cast-in-place, reinforced-concrete decks on the truss spans were made composite with the steel beams during the 1986-1987 rehabilitation. The railroad track is supported on open timber ties, and has a metal grating walkway with cable handrail cantilevered off of the southerly edge of the ties. There are no pedestrian sidewalks on this bridge.

The average daily traffic (ADT) across the bridge is approximately 18,600 vehicles, which includes trucks and emergency response vehicles, and has no posted weight limit. The posted speed limit across the bridge in both directions is 50 miles per hour (mph). The Kansas City Southern Railroad reported to the LADOTD that train traffic fluctuates depending on operating circumstances, but it estimates an average of four freight train crossings of the bridge per day at a speed of less than 5 mph. At the time of the field visit, the bridge was closed to train traffic to accommodate the rehabilitation work that was being completed on some of the railroad approach spans. This bridge is classified as a fracture critical bridge due to the configuration of the truss spans with two truss panels and floorbeams. It is also classified as fracture critical due to the approach spans (highway and rail) on each side of the truss, which represent a two-girder system with a single transverse steel plate girder functioning as the top member of the braced steel tower bents.

There is no pier protection system in the river. The waterway under the center span of the truss span is used for navigation, and has a horizontal clearance of over 600 feet.

The Old Mississippi River Bridge retains many elements of its original construction. The bridge was significantly rehabilitated in 1986-1987. At that time all concrete decks, curbs, walkways, and railings along the highway portions of the bridge were removed and roadway surfaces were widened to provide a 24-foot clear width in each direction, with new cast-in-place, reinforced-concrete decks and concrete curbs. The original rail on the bridge included a decorative fleur de lis detail. Expansion joints were replaced, floorbeams were extended and stiffened, and the cantilever brackets supporting the truss span roadways were strengthened. Existing bridge railings were reinstalled on the widened deck and new tri-beam railing was added to the bottom half of the rail. The steel plate girder approach spans along the highway portions of the bridge were widened as part of this project. The center-to-center girder spacing was increased from 12 feet, 6 inches to 15 feet by moving the existing exterior girders out by 2 feet, 6 inches. The main girders at the top of the steel tower bents were structurally modified to accommodate the revised girder spacing.

Between 2012 and 2016 there were two phases of rehabilitation for this bridge. Phase 1, which began in 2012 and was still ongoing in 2016, consists of rehabilitating the main truss and highway approach spans, as well as some railroad approach spans beginning at Bent 44 on the east and ending at Bent 83 on the west. Rehabilitation work includes repairing, cleaning, and painting the structural steel comprising the substructure and superstructure components.

Phase 2, which began in 2014 and is still ongoing in 2016, consists of rehabilitating the remaining railroad approach spans from the east abutment to Bent 44, and from Bent 83 to the west abutment. The rehabilitation consists of repairing, cleaning, and painting the structural steel comprising the substructure and superstructure components. Additionally, the metal plate walkway on the south side of the track on the steel plate girder railroad spans was replaced with a new metal grating walkway and cable railing. Plan sheets in Appendix B show the limits of the Phase 1 and Phase 2 rehabilitation work.

C. History and significance

The Old Mississippi River Bridge carries four lanes of US 190 and a single railroad track across the Mississippi River between East Baton Rouge and West Baton Rouge Parishes in Baton Rouge. Land use in this area is largely industrial, though a residential development is present to the southwest of the bridge. When planning began, the proposed bridge represented a vital crossing over the Mississippi River for both the highway and the railroad.

Preparation began for construction of the bridge in 1936, with the Bridge Department of the Louisiana Highway Commission (LHC) completing all preparation for the project. Because of the size and importance of the project, bridge designer and LHC engineer Norman E. Lant instituted a process where the LHC served as the supervisor and contractor for the project rather than hiring an outside general contractor, allowing the LHC to cut expenses.⁵ The LHC's 1936-1937 biennial report proudly states:

Previous surveys and preliminary plans made by others for this project were not used, and the work described above, including surveys, borings, plans, specifications, printing of same, analysis of foundation samples and all incidental items of work up to the receipt of bids were accomplished at a cost of less than one-half of one percent of the contract cost. All of this work was carried out by the regular employees of the Bridge Department.⁶

Work for the project was advertised and bids received in May 1937, and a contract awarded two months later.⁷ The bridge required approval from the war department to ensure the Mississippi River remained

⁵ Louisiana Highway Commission, *Ninth Biennial Report of the Louisiana Highway Commission of the State of Louisiana* [Baton Rouge, La.: Louisiana Highway Commission, 1938], 125; Mead & Hunt, Inc., *Historic Context for Louisiana Bridge* (prepared for the Louisiana Department of Transportation and Development, December 2013), 99.

⁶ Louisiana Highway Commission, *Ninth Biennial Report of the Louisiana Highway Commission of the State of Louisiana*, 125-128.

⁷ Louisiana Highway Commission, *Ninth Biennial Report of the Louisiana Highway Commission of the State of Louisiana*, 125.

navigable, which the LHC received in September 1936.⁸ Construction of the bridge was funded with a combination of bonds and federal funds, with \$5.5 million of the expected \$7 million price tag coming from highway bonds and the remainder from regular federal-aid funds, with railroads repaying a portion of the cost to the state for use of the bridge.⁹

While bids for the bridge construction came in over \$1 million higher than the \$7 million earmarked for the project, the LHC expressed no concern that construction would move forward as planned.¹⁰ Construction began as projected in 1937, with the Kansas City Bridge Company serving as contractors for the main substructure.¹¹ However, setbacks occurred during construction as a series of accidents combined with high water levels caused delays in construction of two of the six piers, ultimately causing construction to take a year longer than was planned.¹² The bridge was completed in the summer of 1940 at a total cost of \$9.5 million. A formal dedication held on August 11, 1940, was attended by Louisiana Governor Sam H. Jones and Mississippi Governor Paul B. Johnson.¹³

Construction of the bridge was notable for its use of caissons, which by simple definition are large and watertight boxes or casings in which work is conducted below water level to construct a foundation or pier. All 12 bridges crossing the Mississippi River in Louisiana have caisson foundations, but the Old Mississippi River Bridge applied a circular form (most are rectangular in plan) to provide greater stability against bank movement caused by erosion.¹⁴ The bridge also utilized a new, patented, “sand island” method of caisson design. This method of sinking and controlling the caisson consists of constructing a large island of sand enclosed in a steel shell at the site of each pier, and building the caisson on the island. The caisson is constructed entirely above water, and as each new section is completed the caisson is sunk by open dredging through the island and into the river bed until the desired final depth is reached by the cutting edge.¹⁵

⁸ \$7,000,000 Bridge for Baton Rouge Gets Approval of War Department,” *The Times-Picayune*, September 23, 1936.

⁹ “Baton Rouge Bridge,” *The Times-Picayune*, September 24, 1936. Due to the increasing cost of the bridge, an extra \$1 million in highway bonds was used for construction. Louisiana Highway Commission, *Eleventh Biennial Report of the Louisiana Highway Commission of the State of Louisiana* [Baton Rouge, La.: Louisiana Highway Commission, 1942], sheet 3.

¹⁰ “Bids for Bridge at Baton Rouge Total \$8,360,528,” *The Times-Picayune*, May 27, 1937.

¹¹ Louisiana Highway Commission, *Ninth Biennial Report of the Louisiana Highway Commission of the State of Louisiana*, 125; “Mississippi River Bridge Delayed at Baton Rouge,” *The Times-Picayune*, December 7, 1938.

¹² “Mississippi River Bridge Delayed at Baton Rouge”; “Span Over River at Baton Rouge is Dedicated,” *The Times-Picayune*, August 11, 1940.

¹³ “Span Over River at Baton Rouge is Dedicated,” *The Times-Picayune*, August 11, 1940.

¹⁴ Donald Sorgenfrei, “Caissons of the Mississippi River Bridges,” *The Louisiana Civil Engineer* (August 1997): 5.

¹⁵ Mead & Hunt, Inc., 60; E.S. Blaine, “Practical Lessons in Caisson Sinking from the Baton Rouge Bridge,” *Engineering News-Record* (February 1947): 85-87.

The bridge was designed by Lant, a renowned engineer and bridge designer in the LHC's Bridge Department in the first half of the twentieth century. As head of all bridge engineering work from his start with the agency in 1922 to his retirement in 1955, he oversaw the design and construction of the state's major river crossings, including a number of innovative and complex bridges. This crossing brought Lant international respect as an engineer.¹⁶

The Old Mississippi River Bridge was significantly rehabilitated in 1986-1987, when the roadways on the approach spans and main truss were widened. More recently, beginning in 2012, steel components of the bridge are being repaired, cleaned, and painted.

The Old Mississippi River Bridge is eligible for listing in the National Register under *Criterion C: Engineering*. It is significant as an important example of a distinctive type of truss bridge; specifically, it features a Warren through truss main span that combines continuous and cantilever construction. Additionally, the bridge was engineered to carry both train and vehicular traffic; this was achieved by cantilevering the roadways laterally from the main truss span. The bridge is also notable for its use of caissons during construction, including the new, patented, "sand island" method, which represents a complex engineering solution. The bridge was rehabilitated to widen the roadways, but retains substantial integrity and continues to convey its engineering and design significance.

D. Character-defining features

Character-defining features are prominent or distinctive aspects, qualities, or characteristics of a historic property that contribute significantly to its physical character. Features may include materials, engineering design, and structural and decorative details. Elements of the bridge that are not identified as character-defining features may be historic fabric. Historic fabric is material in a bridge that was part of original construction. It is important to consider both character-defining features and the bridge's historic fabric when planning any work.

Character-defining features of the Old Mississippi River Bridge include the continuous and cantilevered Warren through truss, its cantilevered design to carry both railroad and vehicular traffic, and the caisson-constructed piers (piers 1, 2, 3, 4, and 5) (description below). Other elements that represent historic fabric but are not considered to be character-defining are the railroad approach spans, original materials of the floor system of the main truss spans, bridge railing, and substructure elements including pier 6 and the steel tower bents on the highway and railroad approach spans.

The following items are the character-defining features of this bridge:

Feature 1: Design and construction of a continuous and cantilevered Warren through truss

This feature includes the five continuous and cantilevered steel Warren through truss spans that comprise the main section of the bridge over the Mississippi River measuring 3,326 feet. The Warren truss features diagonal members to withstand both tensile and compressive forces, and added verticals for

¹⁶ Mead & Hunt, Inc., 99.

bracing. In a continuous span design, the superstructure spans uninterrupted over intermediate supports. In cantilevered construction, a span is counterbalanced and/or supported at only one end.

The bridge's five main truss spans consist of a steel cantilever through truss, with two 490-foot-long Warren trusses as the anchor spans at each end; two 848-foot-long cantilevered Warren truss spans, which each include a 396-foot-long suspended span; and one central, 650-foot-long, Warren truss anchor span. Pin-hinged joints are located at the connection between the cantilever truss spans and the suspended spans.



Character-defining feature Photo 1: Design and construction of a continuous and cantilevered Warren through truss.

Feature 2: Cantilevered design to carry both railroad and vehicular traffic

This feature includes the cantilevered design to carry both railroad and vehicular traffic by suspending the roadways laterally from both sides of the truss spans.



Character-defining Feature Photo 2: Cantilevered design to carry both railroad and vehicular traffic by suspending the roadways laterally from both sides of the truss spans.

Feature 3: Caisson-constructed piers

This feature includes the five caisson-constructed piers, comprised of piers 1, 2, 3, 4 and 5, which support the bridge within the waterway limits of the Mississippi River. Caisson construction, consisting of a large watertight casing used to conduct construction below the water level, represents a technological innovation used in large structures requiring deep piers set in unstable soil such as the shifting Mississippi riverbed.



Character-defining Feature Photo 3: Caisson-constructed piers.

The following images illustrate other bridge features that are of historic fabric, meaning they are part of original construction but are not considered to be character-defining features:



Historic Fabric Photo 1: Railroad approach spans to the west of the main truss spans, including braced steel column substructure.



Historic Fabric Photo 2: Original materials of the floor system under the truss spans.



Historic Fabric Photo 3: Original bridge railings along the easterly approach spans.



Historic Fabric Photo 4: Piers and braced steel columns comprise substructure elements on the western approach spans of the bridge.

THIS PAGE INTENTIONALLY LEFT BLANK

4. Engineering Data

A. Existing conditions

(1) Structural observations

The bridge is in satisfactory condition overall and appears to adequately serve its purpose of carrying vehicular traffic and railroad traffic over the Mississippi River and its levees, as well as roads, on each side of the river. There are no major structural deficiencies for this bridge, but there are several minor deficiencies as described below. Rehabilitation of the main truss, highway approach spans, and some railroad approach spans began in 2012 and is expected to be completed in 2016. Rehabilitation of the remaining railroad approach spans began in 2014.

The bridge is not load (weight) posted. According to the latest bridge inspection report (March 3, 2016), this bridge was load (weight) rated in 2012 and determined to be open with no load restrictions. This bridge is inspected annually because of its importance as a major Mississippi River crossing, its unique design and construction features, and because it is a complex, fracture-critical bridge.

Highway portion of the bridge (highway spans are numbered from east to west)

Superstructure

Easterly approach spans 1 through 13:

The approach spans are fracture critical two-girder systems. The 7.5-inch-thick, cast-in-place, reinforced-concrete deck is in fair condition, with transverse cracks and minor scaling noted throughout the deck riding surface. Transverse cracks with efflorescence are noted throughout the deck underside in all spans. The condition of the structural steel is fair. Structural steel members were recently repaired, cleaned, and painted.

The latest bridge inspection report (March 3, 2016) identifies areas of structural steel corrosion where rust is forming.

Fixed and movable bearings are in good condition and have been cleaned and painted. The compression seal deck joints have failed. The open deck joints are partially filled with sand and gravel. The railing system is in good condition.

Main truss spans 14 through 18 over the Mississippi River:

The bottom chords and floorbeams are fracture critical members in this fracture critical through truss system. The deck is cast-in-place reinforced concrete, 6.5 inches thick, and is in fair condition. The riding surface has minor scaling and areas of map cracking noted throughout the deck. Transverse cracking was noted in the deck riding surface with efflorescence noted on the underside of the deck throughout. The condition of the

structural steel is fair. Repairs were made to certain structural steel members prior to cleaning and painting. Structural steel members were recently cleaned and painted. The latest bridge inspection report (March 3, 2016) identifies areas of structural steel corrosion where rust is forming.

The bearings are in good condition as a result of the recent cleaning and painting. The deck joints are in fair condition with minor debris buildup. The finger-type expansion joints are in good condition. The railing system is in good condition.

Westerly approach spans 19 through 45:

The approach spans are fracture critical two-girder systems. The 7.5-inch-thick, cast-in-place concrete deck is in fair condition, with transverse cracks and minor scaling noted throughout the deck riding surface. Transverse cracks with efflorescence are noted throughout the deck underside in all spans. The condition of the structural steel is fair. Structural steel members were recently cleaned and painted. The latest bridge inspection report (March 3, 2016) identifies areas of structural steel corrosion where rust is forming.

Fixed and movable bearings are in good condition and have been cleaned and painted. The compression seal deck joints have failed. The open deck joints are in good condition. The railing system is in good condition.

Substructure

Easterly approach spans 1 through 13, beginning at the east abutment and ending at Pier 1: Braced steel tower bents have fracture critical cap beams. The condition of the structural steel is fair. Structural steel members were recently cleaned and painted. The concrete foundations for the bents are in good condition. Erosion of soil material at the east abutment of the eastbound roadway off-ramp was observed.

Main truss spans 14 through 18 over the Mississippi River, piers 1 through 6:

The concrete piers are in satisfactory condition. According to the March 3, 2016, bridge inspection report, pier 1 has a spall with exposed rebar noted to the cap under fixed bearing 2 and between bearings 3 and 4. Pier 3 has a spall with exposed rebar noted to column 2 near the base. Pier 4 has cracks with efflorescence noted in base and spall with exposed rebar. Vertical cracks were noted in bearing pedestals under the roadway at piers 1 and 6, with large spalls and exposed rebar along the cracks. The bearing pedestal under the westbound roadway at pier 1 has been fiber wrapped. The fiber wrap is damaged and has delaminated in the middle, with a section peeled off.

Westerly approach spans 19 through 45, beginning at pier 6 and ending at the west abutment: The raced steel tower bents have fracture critical cap beams. The condition of the structural steel is fair. Structural steel members were recently cleaned and painted. The concrete foundations for the bents are in good condition.

Railroad portion of the bridge (spans are numbered from east to west for all spans that support the railroad)

The railroad portion of the bridge is closed to train traffic during the current rehabilitation.

Superstructure

Easterly approach spans 1 through 57:

The approach spans are fracture critical, steel, two-girder systems. The railroad ties for the deck are in good condition. The walkway on the south side of the spans was replaced with a new metal grating walkway with cable handrail. The condition of the structural steel is satisfactory. Structural steel members are being repaired, cleaned, and painted.

Main truss spans 58 through 62 over the Mississippi River:

The bottom chords and floorbeams are fracture critical members in this fracture critical through truss system. The railroad ties for the deck are in good condition. The walkway on the south side of the spans was replaced with a new metal grating walkway with cable handrail. The condition of the structural steel is satisfactory. The structural steel members were recently repaired, cleaned, and painted.

Westerly approach spans 63 through 147:

The approach spans are fracture critical two-girder systems. The railroad ties for the deck are in good condition. The walkway on the south side of the spans was replaced with a new metal grating walkway with cable handrail. The condition of the structural steel is satisfactory. Some structural steel members were recently repaired, cleaned, and painted.

Substructure

Easterly approach spans 1 through 57:

The braced steel tower bents have fracture critical cap beams. The condition of the structural steel is fair. As noted in Section 3.B, the approach spans structural steel bents are being repaired, cleaned, and painted. The concrete foundations for the bents are in good condition.

Main truss spans 58 through 62 over the Mississippi River:

(Refer to condition of substructure for highway portion of this bridge.)

Westerly approach spans 63 through 147:

The braced steel tower bents have fracture critical cap beams. The condition of the structural steel is fair. As noted in Section 3.B, the approach spans structural steel bents are being repaired, cleaned, and painted. The concrete foundations for the bents are in good condition.

(2) Non-structural observations

The condition of the asphalt overlay on the roadway approaches to the bridge at both the east and west ends is in fair condition.

Traffic signs are in place at each end of the bridge. No deficiencies in the levees on either side of the river were noted during the site visit.

(3) Serviceability observations

The ADT across the bridge is approximately 18,600 vehicles. This traffic is a mixture of cars, trucks, and emergency response vehicles. The Kansas City Southern Railroad reported to the LADOTD that train traffic fluctuates depending on operating circumstances, but it estimates an average of four freight train crossings of the bridge per day at a speed of less than 5 mph. This bridge does not have accommodations for pedestrians. No deficiencies for vertical clearance over the local roads or the levees were noted. Vertical clearance for the railroad portion of the bridge over the CNRR on the east side is adequate. Vertical clearance for the US 190 roadway under the CNRR bridge is noted as 13 feet, 6 inches, which is substandard; however, this location is off of the Old Mississippi River Bridge.

B. Sources of information

Plans available:	Yes, available at the LADOTD Bridge Section office
Inspection report date:	March 3, 2016 (highway portion of bridge only)
Fracture critical report date:	(included as part of routine inspection report; does not include railroad portion of bridge)
Underwater inspection report:	July 2013
Date of site visit:	February 4, 2016



Condition Photo 1: Overview of bridge looking east, with highway signage and entrance ramp to go east on US 190.



Condition Photo 2: Westbound US 190 exit ramp structure, north side, west end of bridge.



Condition Photo 3: Steel girder span expansion bearings at braced steel bent.



Condition Photo 4: South side of steel girder approach span, showing widened roadway deck and bridge railing details including attachment.



Condition Photo 5: Eastbound US 190 roadway on-ramp approach spans, looking east.



Condition Photo 6: Westbound US 190 exit ramp roadway at west end of bridge, looking east.



Condition Photo 7: Eastbound approach spans and railroad bridge spans, looking east from westerly side of bridge.



Condition Photo 8: Steel tower bent and approach spans at River Road.



Condition Photo 9: Pier 1 and three approach spans supported on pier; beginning of truss span, looking at eastbound roadway.



Condition Photo 10: Truss span at pier 2, looking east.



Condition Photo 11: Underside of truss span 1; railroad in middle, highway on each side.



Condition Photo 12: Eastbound roadway across truss span, looking east.



Condition Photo 13: Eastbound roadway off-ramp, looking east. Note progress of cleaning and painting the railroad portion of the bridge (as of February 2016 site visit).



Condition Photo 14: Eastbound roadway off-ramp, looking west along frontage road. Note progress of cleaning and painting railroad portion of bridge (as of February 2016 site visit).



Condition Photo 15: Truss spans, looking northwest.



Condition Photo 16: Pier 6 and approach spans supported on pier; beginning of truss span, looking at eastbound roadway.



Condition Photo 17: Main river piers 5, 4, 3 and 2 (pier 2 in foreground).



Condition Photo 18: Underside of railroad portion of east approach spans; shows bolted strengthening of floor beam bottom flange.



Condition Photo 19: Eastbound roadway east abutment showing erosion under bridge.



Condition Photo 20: Eastbound roadway at east abutment; note bridge deck expansion joint and approach road pavement condition.



Condition Photo 21: View of typical minor rust stains to floorbeams and steel members found throughout the structure. (Photo courtesy of LADOTD from March 3, 2016, inspection report.)



Condition Photo 22: View of typical minor rust stains to girders at saddle bearings found throughout the structure. (Photo courtesy of LADOTD from March 3, 2016, inspection report.)



Condition Photo 23: View of fiber wrap failing on pier 1 north side. (Photo courtesy of LADOTD from March 3, 2016, inspection report.)



Condition Photo 24: Railroad west approach spans, looking west, repaired and painted.



Condition Photo 25: Railroad west approach spans, looking east, repaired and painted.



Condition Photo 26: Bearing rehabilitation at west abutment of railroad west approach spans.



Condition Photo 27: Railroad westerly approach spans, cleaning and painting with containment system, looking east (as of February 2016 site visit).



Condition Photo 28: Railroad easterly approach spans over the CNRR, to be painted in 2016, looking east. Note vertical clearance sign for eastbound US 190 under the CNRR bridge.



Condition Photo 29: Railroad easterly approach spans to be painted in 2016, looking west.



Condition Photo 30: Railroad east approach spans deck, looking west; walkway to be removed and replaced in 2016 with a metal grating walkway with cable handrail.



Condition Photo 31: Expansion bearings for railroad girders at east abutment.

5. Recommendations

This Preservation Priority Bridge should remain in use and can meet current and projected transportation needs for the next 20 years or more. Maintenance and rehabilitation activities should be completed in a manner consistent with the long-term preservation of this historic bridge. The Statewide Historic Bridge Plan provides additional guidance and approaches to completing maintenance and rehabilitation activities that adhere to the Secretary's Standards. Work should be conducted under the supervision of a qualified professional historian, as defined in the PA. The bridge engineer, or the bridge engineer's supervising engineer, should have demonstrated expertise in historic bridge projects and must have completed the LADOTD's historic bridge training. When developing plans and specifications for a project, the bridge engineer should follow the recommendations below.

Under the terms agreed upon in the PA, the bridge owner may undertake certain activities that are considered to be best practices without additional consultation or public notification. These activities are documented in Attachment 5 of the PA and are limited to the activities specifically noted. All recommended preventative maintenance and rehabilitation activities for this bridge are included in Attachment 5 and are not expected to alter character-defining features or historic fabric of the bridge. Some cyclical or condition-based maintenance items are noted below under Rehabilitation because they are expected to be completed as part of an overall rehabilitation project for this bridge. These activities may need to be completed as conditions dictate to promote long-term preservation of this historic bridge. Recommendations within this Plan should be reviewed in 10 years following completion of the plan to identify any needed updates or revisions.

The opinions of probable costs provided below are in 2016 dollars. The costs were developed without benefit of preliminary rehabilitation plans and are based on the above identified tasks using engineering judgment and/or gross estimates of quantities and historic unit prices and are intended to provide a programming level of estimated costs. Refinement of the probable costs is recommended once preliminary plans have been developed. The estimated preservation costs include a 10% contingency and 7% mobilization allowance of the preservation activities, excluding soft costs. Actual costs may vary significantly from those opinions of cost provided herein. Engineering design, historical consultation, and construction administration costs are not included as these may be provided by the owner or consultants.

Maintenance responsibility for this bridge is shared by the LADOTD and the KCS Railroad. Refer to Appendix C for an exhibit that shows which elements of the bridge are the maintenance responsibility of the LADOTD and which elements are the maintenance responsibility of the KCS Railroad.

A. Preventative maintenance

There are no cyclical maintenance activities recommended, other than those which are being routinely performed, such as the annual bridge inspections.

There are no condition-based maintenance activities recommended.

B. Rehabilitation

The following are recommendations for rehabilitation of the highway components of the bridge only, not for the railroad components. These activities should be performed when necessary (estimated to be within the next two years):

As noted previously, rehabilitation of the superstructure and substructure units has been underway since 2012 including repairing, cleaning, and painting steel components. Since rehabilitation work is underway, structural steel repairs to truss and highway and railroad approach spans are not included in the recommendations or cost estimates for this plan.

1. Install collection troughs under finger-type expansion joints in the main truss spans bridge decks, to direct water and debris away from the structural steel members and bearings below.
2. Remove and replace bridge deck compression joint seals in the easterly and westerly approach spans.
3. Repair concrete spalls with exposed rebar in the cap of Pier 1.

Bridge Recall No. 051880		Date:	7/27/2016	
Old Mississippi River (Huey P. Long) Bridge				
Opinion of Probable Costs				
Rehabilitation				
Item	Quantity	Unit	Unit Cost	Total
Install collection troughs under finger-type expansion joints in the truss spans concrete decks	192	LF	\$150	\$28,800
Remove and replace bridge deck compression joint seals in the easterly and westerly approach spans	960	LF	\$75	\$72,000
Repair concrete spalls with exposed rebar in the cap of Pier #1	1	LS	\$20,000	\$20,000
Traffic control for work on bridge decks for troughs and joints	1	LS	\$75,000	\$75,000
Item Subtotal				\$195,800
Contingency			10.00%	\$19,580
Mobilization			7.00%	\$15,077
TOTAL ESTIMATED CONSTRUCTION COST				\$230,457
			Round to:	\$230,000

C. Identification of any anticipated design exceptions

No design exceptions are recommended.

Appendix A. Historic Inventory Form

THIS PAGE INTENTIONALLY LEFT BLANK

Louisiana Historic Bridge Inventory

Recall Number: 051880

Structure Number: 61170071000001

SHPO Number: 17-01653

Bridge Name: MISSISSIPPI RIVER (B.R.)

Location Data:

District: 61

Parish: East Baton Rouge

Feature Crossed: OLD MISS.RIVER BR

Facility Carried: US0190

Location: US0190

City, Village or Town (if applicable): Baton Rouge

Status: Open

Bridge Owner: State of Louisiana

Latitude: 30.507133

Longitude: -91.1912

Structural Data:

Bridge Type: Steel High Truss (Cantilevered Through Truss)

Year Built: 1939

Main Span Configuration (if applicable): Warren truss

Maximum Span Length (feet): 748

Number of Spans: 5

Overall Structure Length (feet): 5879

Approach Span Type (if applicable): Steel girder and floorbeam system

Posted Load:

Current ADT: 023800

Design and Construction Data:

Engineer or Builder:

Norman Lant

Bridge Plaque:

None

National Register of Historic Places Evaluation:

This steel through truss bridge, known as the Huey P. Long Bridge, has significance as a distinctive example of a truss bridge. Significance is demonstrated in the cantilevered design and the Warren truss configuration, comprised of diagonals to withstand tensile and compressive forces. In addition, the bridge was engineered to carry both train and vehicular traffic. The bridge was rehabilitated in 1989 to widen the roadway but retains integrity and continues to convey its engineering and design significance. The bridge is eligible for listing in the National Register under *Criterion C: Design/Engineering*.

Within/Adjacent to Known Historic District: N/A

National Register Historic District Name: N/A

National Register Determination: Previously determined eligible

National Register Determination Date: 7/26/2011

Surveyor: Mead & Hunt, Inc.

Date Surveyed: 2013



Louisiana Historic Bridge Inventory

Recall Number: 051880

Structure Number: 61170071000001

Bridge Name: MISSISSIPPI RIVER (B.R.)

Parish: East Baton Rouge

Bridge Owner: State of Louisiana

Feature Crossed: OLD MISS.RIVER BR

Facility Carried: US0190

Photographs:

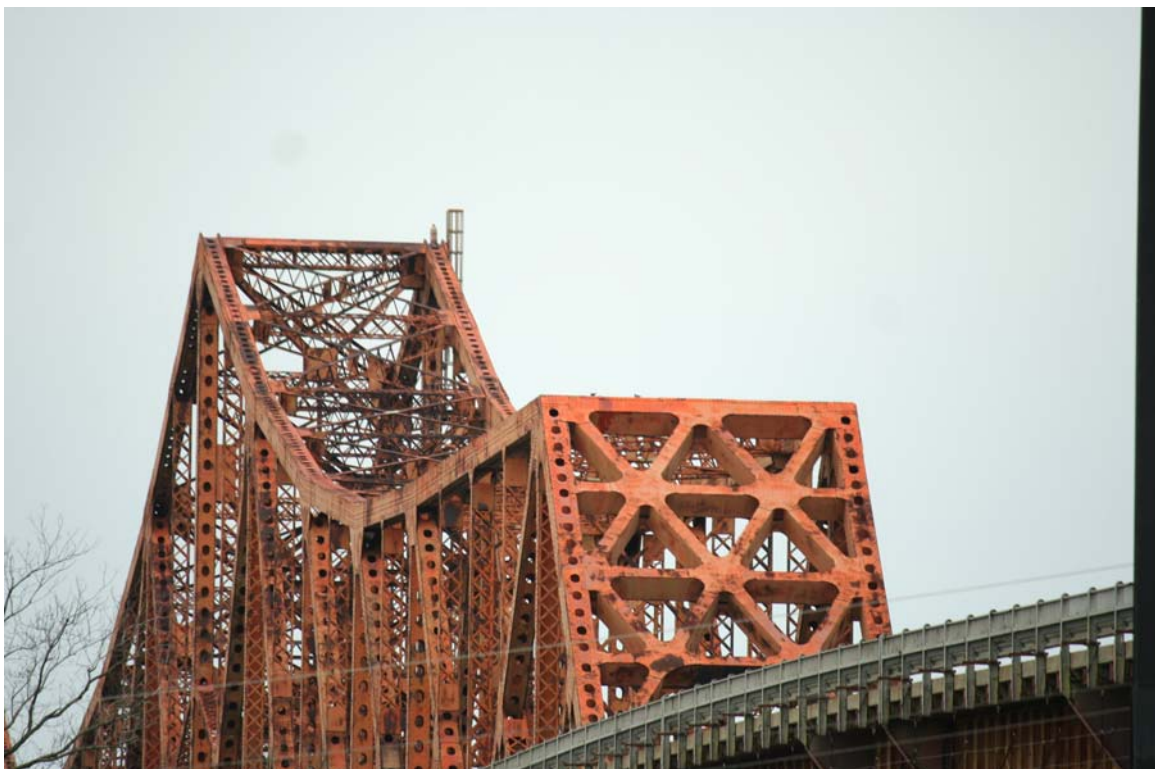

Appendix B. Select Plan Sheets

THIS PAGE INTENTIONALLY LEFT BLANK

E.A.P.	STATE PROJECT	PARISH	SHEET NO.
BHF-03-0104	7-10-31	EAST & WEST BATON ROUGE	6

- WORK ITEMS**
- CONTRACTOR TO PERFORM SUPPLEMENTAL REPAIRS AS FOLLOWS:
- PROVIDE AND INSTALL GIRDER BRACING CONNECTION PLATES AND INSPECTION RODS PER SHEET NO. 7.
 - PROVIDE AND INSTALL STRINGER BRACING CONNECTION PLATES PER SHEET NO. 8.
 - CLIP RAILROAD TOWER BRACING CONNECTION PLATES PER SHEET NO. 8.
 - PROVIDE ALL MATERIALS TO SITE FOR NEW HANDRAIL SYSTEM PER SHEETS NO. 9 AND 10. INSTALLATION WILL BE BY OTHERS.
 - PROVIDE ALL MATERIALS TO SITE FOR REPLACEMENT OF DETERIORATED PORTIONS OF WALKWAY PLATES AND MISSING PLATE FASTENERS PER SHEET NO. 11. INSTALLATION WILL BE BY OTHERS.
 - RAISE WEST ABUTMENT BACKWALL PER SHEET NO. 11.

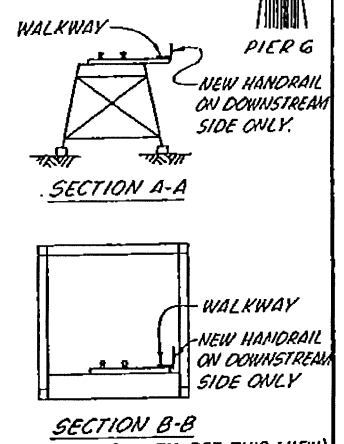
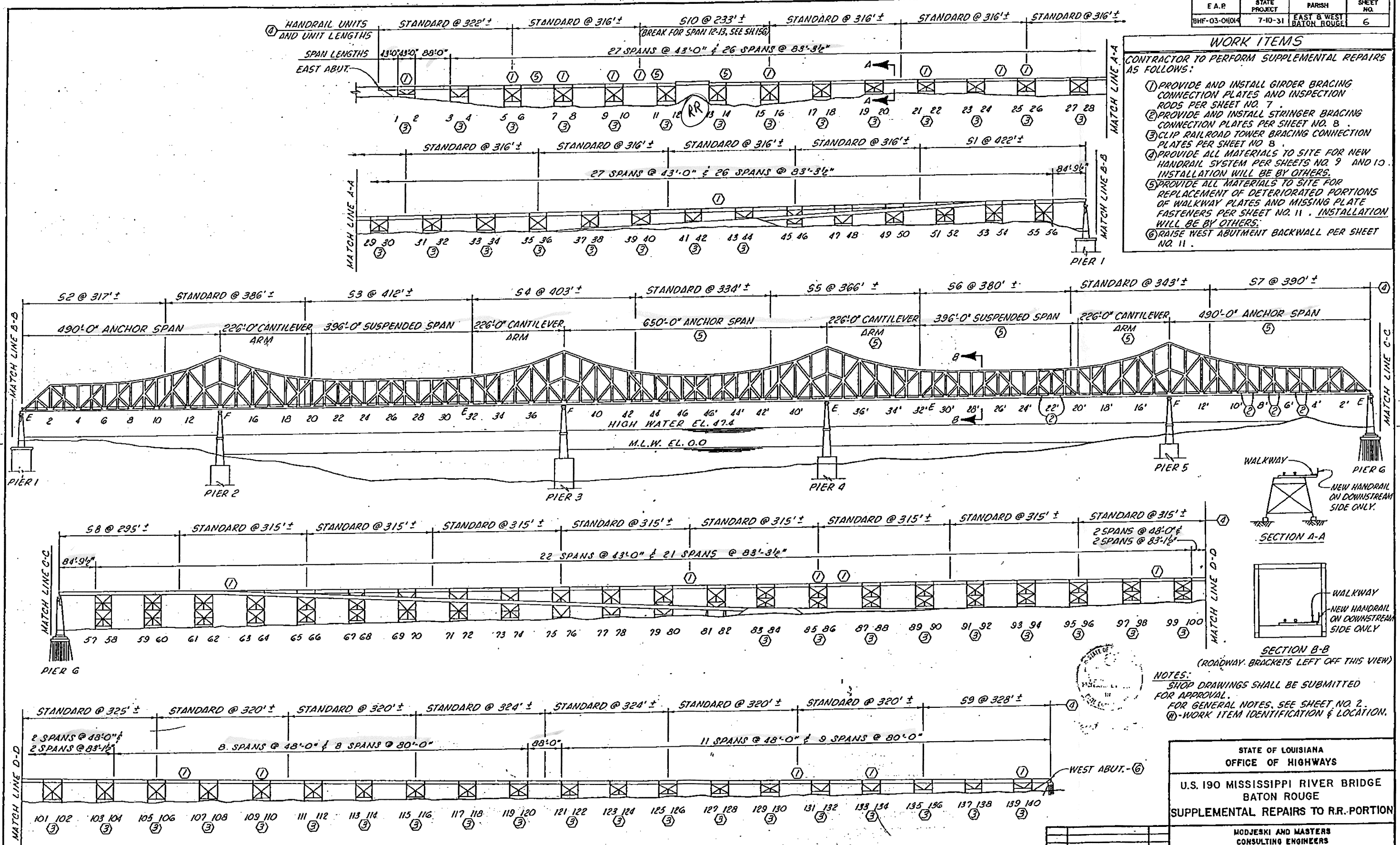

NOTES:

SHOP DRAWINGS SHALL BE SUBMITTED FOR APPROVAL.

FOR GENERAL NOTES, SEE SHEET NO. 2.

⑥-WORK ITEM IDENTIFICATION & LOCATION.

DATE	DESCRIPTION	BY	DATE	SCALE	DRAWING NO.
			AUG. 1987	1"=100'-0"	6
	REVISIONS				

STATE OF LOUISIANA
OFFICE OF HIGHWAYS

U.S. 190 MISSISSIPPI RIVER BRIDGE
BATON ROUGE

SUPPLEMENTAL REPAIRS TO R.R. PORTION

MODJESKI AND MASTERS
CONSULTING ENGINEERS

DRAWN BY: F.A. CHD. BY: L.E.L. IN CHARGE: D.F.S. APPROVED: J.W.C.

F.A.P.	STATE PROJECT	PARISH	SHEET NO.
BHF03-01(009)	007-10-28	EAST BATON ROUGE	2

- KEY**
- 1 BRIDGE ROADWAY REMOVAL (BID ITEM S101)
 - 2 BRIDGE RAILING REMOVAL (BID ITEM S102)
 - 3 APPROACH ROADWAY WIDENING - STRUCTURAL STEELWORK (BID ITEM S103)
 - 4 APPROACH SUBSTRUCTURE WORK (BID ITEM S104)
 - 5A RAILROAD TOWER DAMAGE REPAIRS - TOWER 15-16 & BENT 42 (BID ITEM S105A) NOT SHOWN
 - 5B RAILROAD TOWER DAMAGE REPAIRS - TOWER 83-84 (BID ITEM S105B)
 - 6 MAIN BRIDGE WIDENING - STRUCTURAL STEEL WORK (BID ITEM S106)
 - 7A EXISTING BRIDGE RAILING - REPLACEMENT POST (BID ITEM S107A) NOT SHOWN
 - 7B EXISTING BRIDGE RAILING - REPLACEMENT PANEL (BID ITEM S107B) NOT SHOWN
 - 7C EXISTING BRIDGE RAILING - REFURBISHING & REPLACEMENT (BID ITEM S107C)
 - 8 TUBULAR TRI-BEAM RAILING (BID ITEM S108)

- 9 MAIN BRIDGE BRACING MEMBERS (BID ITEM S109)
- 10 SUB-VERTICAL REPAIRS - TYPE I-V (BID ITEMS S110A - S110E)
- 11 TOP LATERAL REPAIRS (BID ITEM S111)
- 12 WIND TRUSS REPAIRS (BID ITEM S112)
- 13 FALSE CHORD REPAIRS (BID ITEM S113)
- 14 MAIN BRIDGE P.P. 29'-28' COLLISION DAMAGE REPAIRS (BID ITEM S114)
- 15 CRACKED STRINGER CONNECTION REPAIRS (BID ITEM S115)
- 16 MAIN BRIDGE P.P. 37-38 COLLISION DAMAGE REPAIRS (BID ITEM S116)
- 17 STRINGER RELIEF JOINT REPAIRS (BID ITEM S117) NOT SHOWN
- 18 PIER TOP RAILING POST REPAIR (BID ITEM S118)
- 19 EXPANSION BEARING OIL BATH REPAIR (BID ITEM S119)
- 20 AIR LINE REMOVAL (BID ITEM S120)
- 21 PLATE CLIPPINGS (BID ITEM S121) NOT SHOWN

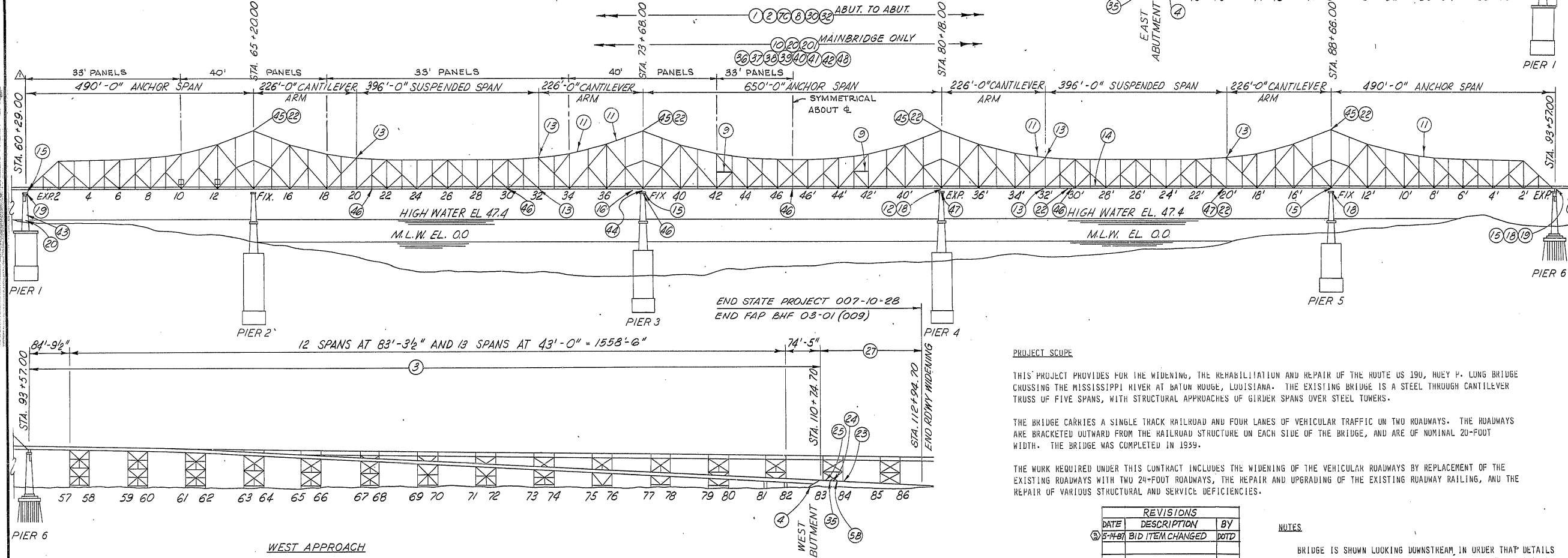
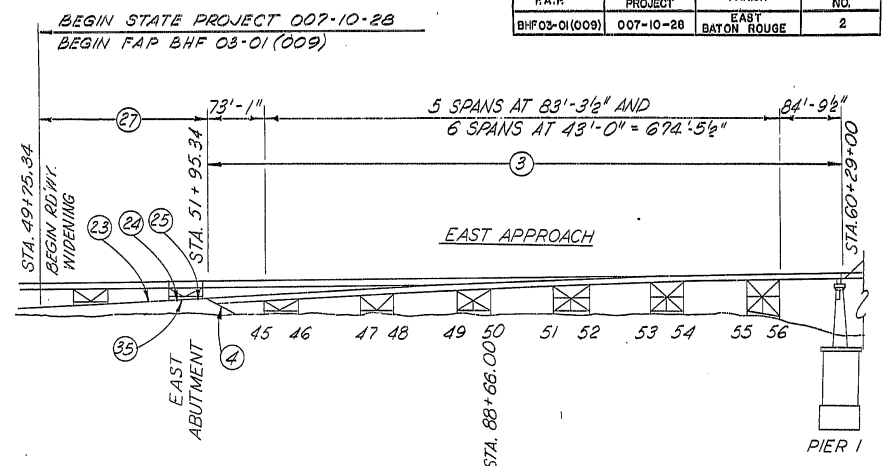

PROJECT SCOPE

THIS PROJECT PROVIDES FOR THE WIDENING, THE REHABILITATION AND REPAIR OF THE ROUTE US 190, HUEY P. LONG BRIDGE CROSSING THE MISSISSIPPI RIVER AT BATON ROUGE, LOUISIANA. THE EXISTING BRIDGE IS A STEEL THROUGH CANTILEVER TRUSS OF FIVE SPANS, WITH STRUCTURAL APPROACHES OF GIRDER SPANS OVER STEEL TOWERS.

THE BRIDGE CARRIES A SINGLE TRACK RAILROAD AND FOUR LANES OF VEHICULAR TRAFFIC ON TWO ROADWAYS. THE ROADWAYS ARE BRACKETED OUTWARD FROM THE RAILROAD STRUCTURE ON EACH SIDE OF THE BRIDGE, AND ARE OF NOMINAL 20-FOOT WIDTH. THE BRIDGE WAS COMPLETED IN 1939.

THE WORK REQUIRED UNDER THIS CONTRACT INCLUDES THE WIDENING OF THE VEHICULAR ROADWAYS BY REPLACEMENT OF THE EXISTING ROADWAYS WITH TWO 24-FOOT ROADWAYS, THE REPAIR AND UPGRADING OF THE EXISTING ROADWAY RAILING, AND THE REPAIR OF VARIOUS STRUCTURAL AND SERVICE DEFICIENCIES.

REVISIONS		
DATE	DESCRIPTION	BY
5-14-87	BID ITEM CHANGED	DOTD

NOTES

BRIDGE IS SHOWN LOOKING DOWNSTREAM IN ORDER THAT DETAILS WILL BE SEEN IN THE SAME SENSE AS SHOWN ON THE ORIGINAL CONTRACT DRAWINGS AND THE SHOP DRAWING.

- 22 ACCESS LADDERS AND PLATFORMS (BID ITEM S122)
- 23 BLOCKED OUT GUARDRAIL (BID ITEM 704(3))
- 24 GUARDRAIL ANCHOR SECTIONS (B.C.T.) (BID ITEM 704(5))
- 25 GUARDRAIL TRANSITIONS (BID ITEM 704(8))
- 26 TEMPORARY SIGNS & BARRICADES (BID ITEM 713(1)) NOT SHOWN
- 27 PAVEMENT WIDENING (BID ITEM 724(2))
- 28 TEMPORARY DETOUR ROADS (BID ITEM 732(2)) NOT SHOWN
- 29 MOBILIZATION (BID ITEM 727(1)) NOT SHOWN
- 30 CLASS AA CONCRETE (BID ITEM 805(3)) EXPANSION JOINT SEAL (BID ITEM 805(9))
- 31 STRIP SEAL (4") (BID ITEM 5-180)
- 32 DEFORMED REINFORCING STEEL (BID ITEM 806(1))

- 33 STEEL (A572) (BID ITEM 807(4)) NOT SHOWN
- 34 STRUCTURAL METAL WORK (BID ITEM 807(6)) NOT SHOWN
- 35 CONCRETE APPROACH SLABS (BID ITEM 813(1))
- 36 CONDUIT WITH CONDUCTORS (BID ITEM 730(2)(A))
- 37 CONDUIT WITH CONDUCTORS (BID ITEM 730(2)(B))
- 38 CONDUIT WITH CONDUCTORS (BID ITEM 730(2)(C))
- 39 CONDUIT WITH CONDUCTORS (BID ITEM 730(2)(D))
- 40 CONDUIT WITH CONDUCTORS (BID ITEM 730(2)(E))
- 41 CONDUIT WITH CONDUCTORS (BID ITEM 730(2)(F))
- 42 CONDUIT WITH CONDUCTORS (BID ITEM 730(2)(G))
- 43 ELECTRICAL SERVICES (BID ITEM 730(10))

- 44 FOGHORN SYSTEM (BID ITEM S301)
- 45 AIRWAYS BEACON (BID ITEM S302)
- 46 CHANNEL LIGHTS (BID ITEM S303)
- 47 RED NEON LIGHTS (BID ITEM S304)
- 48 ENCLOSURES (BID ITEM S305)
- 128 CERAMIC ROAD MARKERS (BID ITEM S128) NOT SHOWN
- 129 REPLACEMENT OF CERAMIC ROAD MARKERS (BID ITEM S129) NOT SHOWN
- 130 TEMPORARY PAVEMENT MARKINGS (BID ITEM 718(2)) NOT SHOWN

- 201 RAILROAD FLOORBEAM MODIFICATIONS (BID ITEM S201)
- 202 RAILROAD FLOORBEAM WEB REPAIRS (BID ITEM S202) NOT SHOWN
- 203 RAILROAD FLOORBEAM PATCH (BID ITEM S203) NOT SHOWN
- 204 RAILROAD TOWER SHIMMING (BID ITEM S204) NOT SHOWN
- 123 CONSTRUCTION LAYOUT (BID ITEM S123) NOT SHOWN
- 124 FLEXIBLE POST TRAFFIC DELINEATORS (BID ITEM S124) NOT SHOWN
- 125 REPLACE OF FLEXIBLE POST TRAFFIC DELINEATORS (BID ITEM S125) NOT SHOWN
- 126 IMPACT ATTENUATOR (D.O.T.D. OWNED) (BID ITEM S126) N.S.
- 127 TEMPORARY PRECAST BARRIERS (15' UNIT) (BID ITEM S127) N.S.

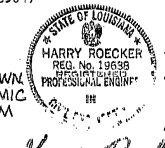

STATE OF LOUISIANA
OFFICE OF HIGHWAYS

U.S 190 MISSISSIPPI RIVER BRIDGE
BATON ROUGE

PROJECT SCOPE & KEY DIAGRAM

MODJESKI AND MASTERS
CONSULTING ENGINEERS

DATE	DESCRIPTION	BY	DATE	SCALE	DWG. NO.
AUG. 1, 1985				1" = 10'-0"	2

DRAWN BY: TAB CHD. BY: HRR IN CHARGE: DFS APPROVED: WBC

FAP	STATE PROJECT	PARISH	SHEET NO.
BHF-03-01009	007-10-28	EAST BATON ROUGE	101

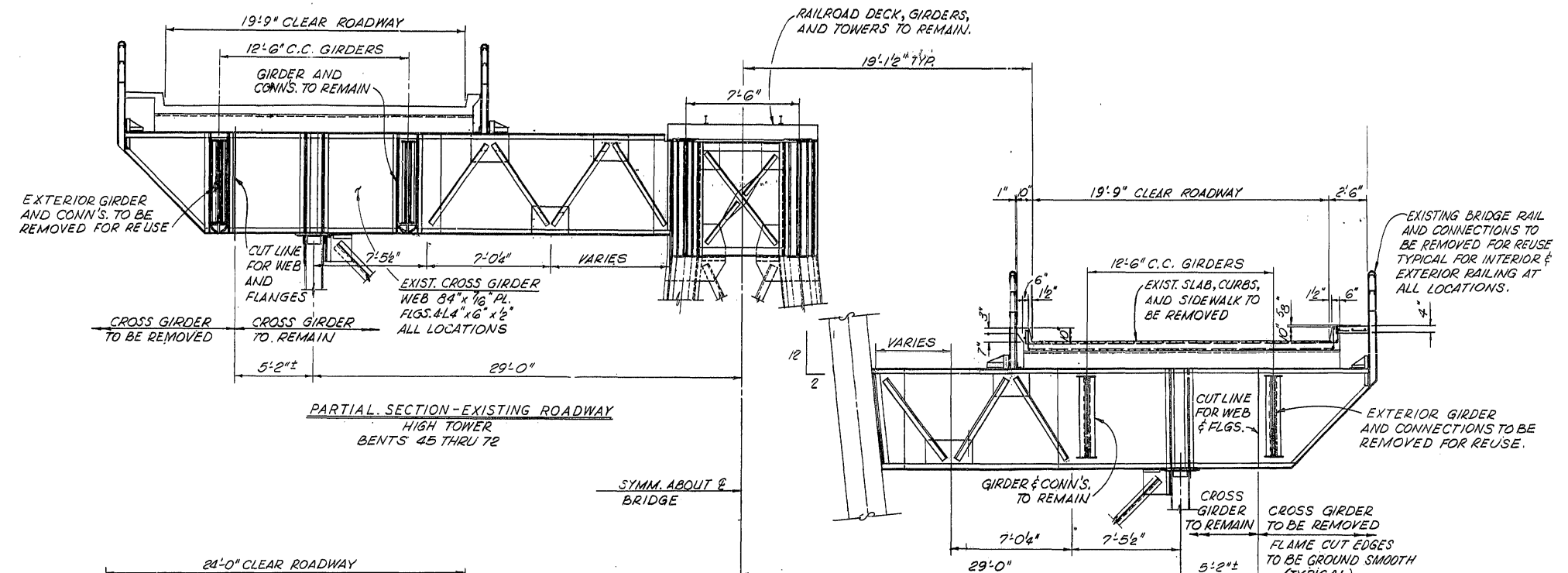

PARTIAL SECTION-EXISTING ROADWAY
HIGH TOWER
BENTS 45 THRU 72

SYMM. ABOUT C
BRIDGE

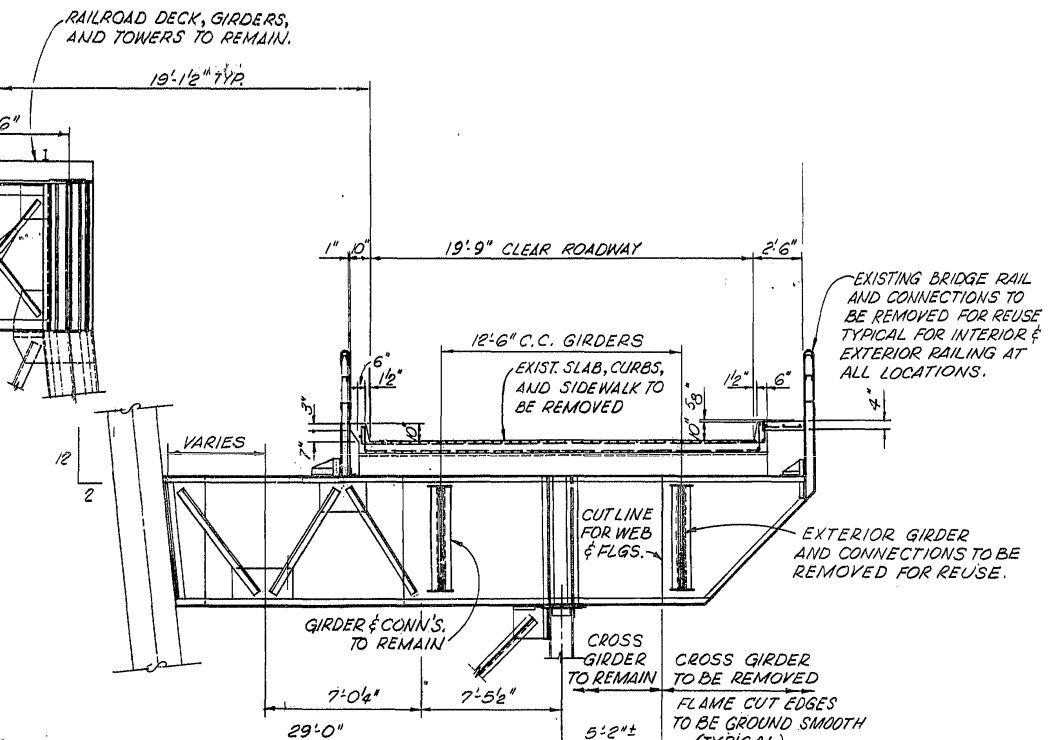

PARTIAL SECTION-EXISTING ROADWAY
(FIXED END SHOWN)
BENT 73 THRU 80

SYMM. ABOUT C
BRIDGE

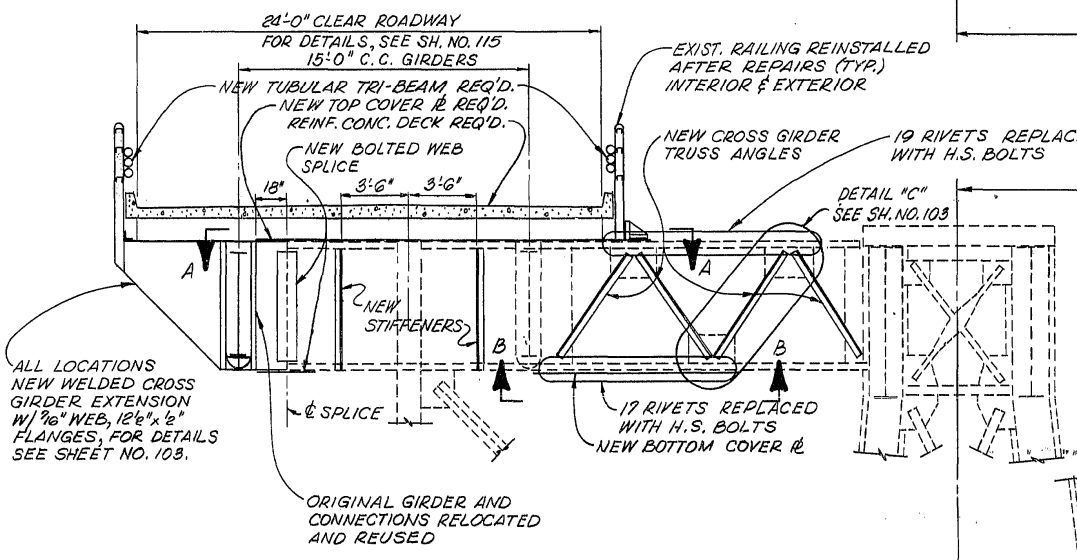

PARTIAL SECTION-PROPOSED ROADWAY
(EXPANSION END SHOWN)
BENTS 45 THRU 72

SYMM. ABOUT C
BRIDGE

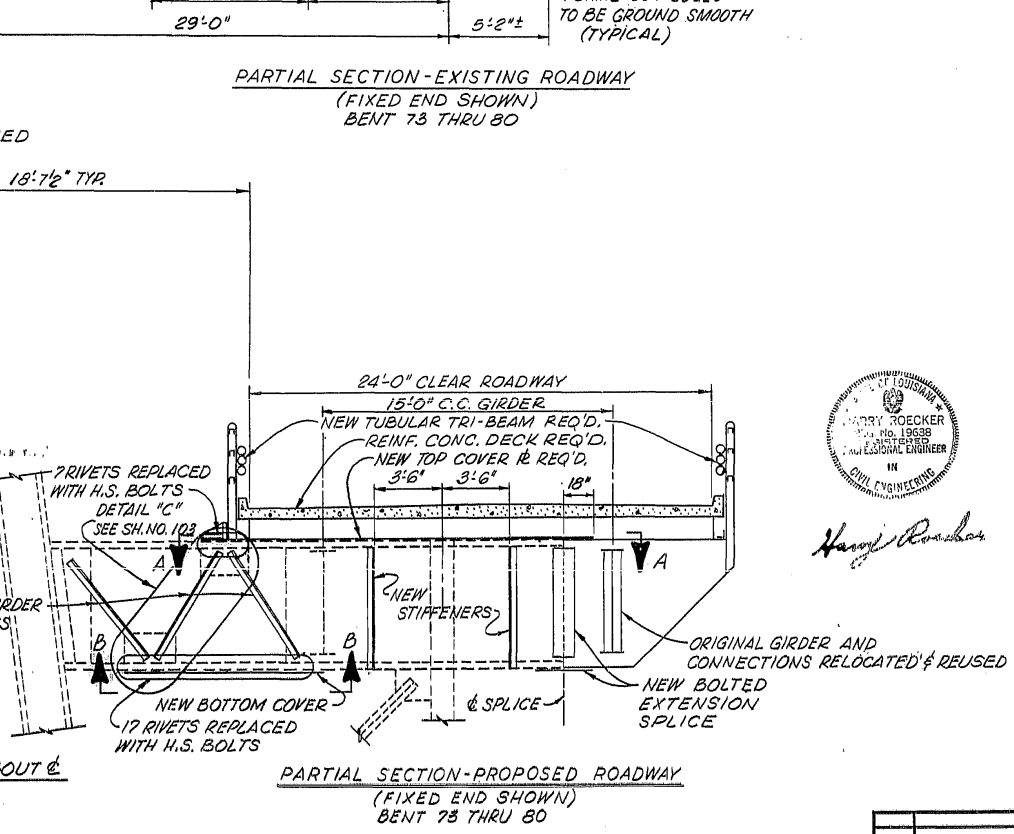

PARTIAL SECTION-PROPOSED ROADWAY
(FIXED END SHOWN)
BENT 73 THRU 80

APPROACH ROADWAY WIDENING
GENERAL WORK DESCRIPTION

ROADWAY REMOVAL
(PAYMENT INCLUDED IN BID ITEM S101 - BRIDGE ROADWAY REMOVAL)

REMOVE REINFORCED CONCRETE ROADWAY DECK, CURBS, AND SIDEWALK INCLUDING DRAINS AND DRAIN PIPES. REMOVE STEEL SUB-FLOORBEAMS AND ROADWAY DAMS. ALL MATERIALS SHALL BE REMOVED IN A CONTROLLED MANNER AND SHALL NOT BE ALLOWED TO FALL FROM THE BRIDGE.

THE COMPLETE WORK DESCRIPTION OF BRIDGE ROADWAY REMOVAL INCLUDES THIS WORK, MAIN BRIDGE WIDENING - ROADWAY REMOVAL (SHEET NO. 108), AND APPROACH SLAB REMOVAL (SHEET NO. 106).

ALL REMOVED MATERIAL SHALL BE REMOVED FROM THE SITE.

BRIDGE RAIL REMOVAL
(INCLUDED IN BID ITEM S102 - BRIDGE RAILING REMOVAL)

REMOVE ALL BRIDGE RAILING SECTIONS, POSTS, AND PUST CONNECTIONS. ALL PIECES SHALL BE MATCH MARKED AS REQUIRED FOR REINSTALLATION OF COMPONENTS.

THE COMPLETE WORK DESCRIPTION OF EXISTING BRIDGE RAILING REMOVAL INCLUDES THIS WORK AND MAIN BRIDGE WIDENING - BRIDGE RAIL REMOVAL (SHEET NO. 108).

STRUCTURAL STEEL WORK
(BID ITEM S103)

REMOVE GIRDER SWAY AND LATERAL BRACING. REMOVE EXTERIOR GIRDERS WITH CONNECTIONS AND REFORBISH FOR REUSE. EXTEND CROSS GIRDERS. INSTALL CROSS BEAMS AND REPOSITION EXTERIOR GIRDERS AS SHOWN. COVER PLATE CROSS GIRDER FLANGES. INSTALL CROSS GIRDER STIFFENERS. REPLACE CROSS GIRDER TRUSS ANGLES. INSTALL NEW GIRDER BRACING AND BRACE HIGHWAY COLUMNS. REPLACE DESIGNATED RIVETS WITH HIGH STRENGTH BOLTS.

THE CONTRACTOR SHALL BE RESPONSIBLE FOR MAINTAINING STRUCTURAL STABILITY OF BRIDGE MEMBERS DURING ALL WORK.

CONSTRUCTION SEQUENCING AND FALSE WORK SHALL BE SUBMITTED TO THE ENGINEER FOR REVIEW.

STEEL (A572)
(PAYMENT TO BE MADE UNDER BID ITEM 807(4))

INSTALL APPROACH SUBFLOORBEAMS AND LONGITUDINAL BRACKETS ATOP APPROACH GIRDERS AS SHOWN.

TOTAL BID ITEM 807(4) STEEL (A572) INCLUDES THIS WORK AND MAIN BRIDGE ROADWAY WIDENING NEW ROADWAY STRINGERS.

FOR GENERAL NOTES SEE SHEET NO. 3.
FOR EXISTING RAILING DETAILS SEE APPENDED SHOP DRAWINGS.
FOR DETAILS AND VIEWS SEE SHEET NOS. 102-104.
FOR RELATED WORK SEE SHEET NOS 105, 106, 107.
FOR PROPOSED BRIDGE RAILING SEE SHEET NO. 127, 128.
FOR PROPOSED DECK SEE SHEET NO. 115.

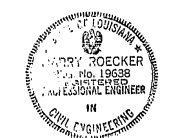

Harry Roegner

STATE OF LOUISIANA
OFFICE OF HIGHWAYS
U.S. 190 MISSISSIPPI RIVER BRIDGE
AT BATON ROUGE
APPROACH STRUCTURE WIDENING
BRIDGE SECTIONS

MODJESKI AND MASTERS CONSULTING ENGINEERS	
DATE	DESCRIPTION
BY	REVISIONS
DATE: AUG., 1985	SCALE: 1/4" = 1'-0"
DRAWN BY: JDB	CHECKED BY: HRR
IN CHARGE: DFB	APPROVED: WBC

F. A. R.	STATE PROJECT	PARISH	SHEET NO.
BHF-03-01(009)	007-10-28	EAST BATON ROUGE	102

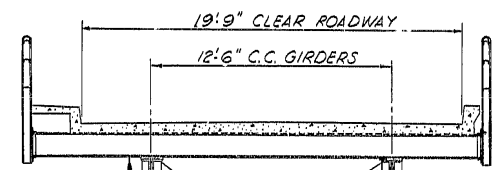
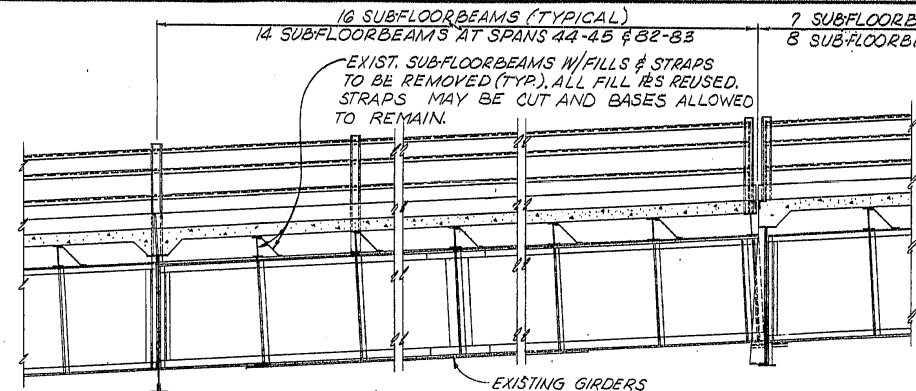

Harry Roeker

BRACING ALTERNATES
 1) SHOP WELDED/FIELD BOLTED CONNECTIONS
 2) WT 7x15 SPLIT FROM EXIST. SUB-FLOORBEAMS USED AS SWAY FRAME BOTT. STRUTS.

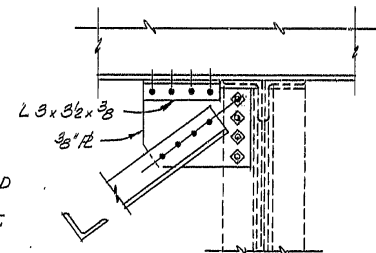

NOTE: HANDRAIL PICKETS NOT SHOWN.

EXISTING ROADWAY GIRDER ELEVATIONS
SCALE: 1/4"=1'-0"

EXISTING ROADWAY-TYPICAL SECTION
SCALE: 1/4"=1'-0"

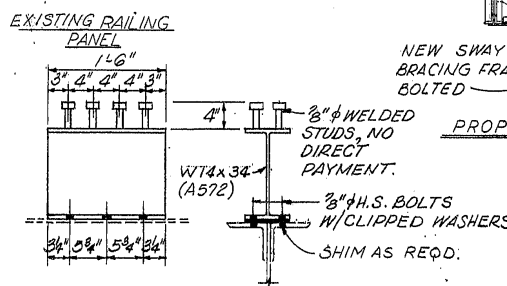
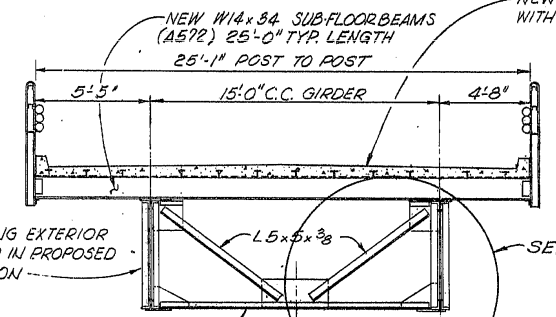
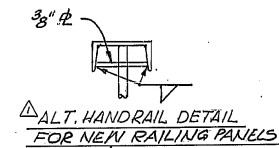
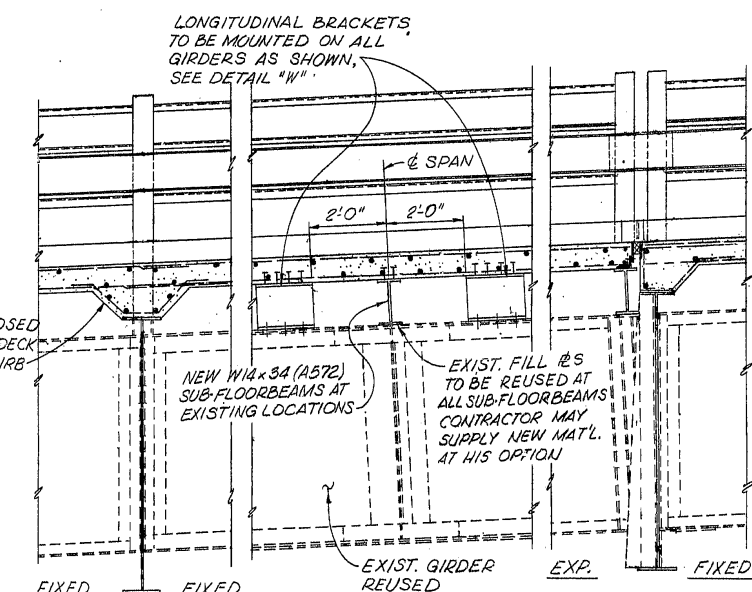

PROPOSED ROADWAY-TYPICAL SECTION
SCALE: 1/4"=1'-0"

DETAIL 'X'
SCALE: 1"=1'-0"

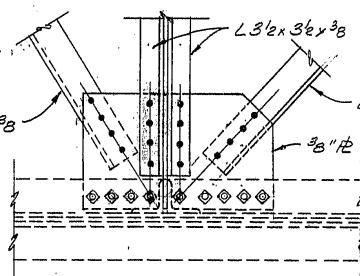

DETAIL 'Z'
SCALE: 1"=1'-0"

- KEY:
- EXISTING RIVET
 - ◊ HIGH STRENGTH BOLT CONNECTING NEW MATERIAL TO EXISTING. NEW HOLE MUST MATCH EXISTING.
 - ⊙ EXISTING RIVET REPLACED WITH HIGH STRENGTH BOLT
 - HIGH STRENGTH BOLT IN NEW FASTENER LOCATION

NOTES

FOR GENERAL NOTES SEE SHEET NO. 3.

FOR GENERAL WORK DESCRIPTIONS AND VIEW REFERENCES SEE SHEET NO. 101.

FOR EXISTING RAILING DETAILS SEE APPENDED SHOP DWGS.

FOR EXISTING EXPANSION DAM DETAILS SEE SHEET NO. 117.

FOR ADDITIONAL APPROACH ROADWAY WIDENING DETAILS SEE SHEET NOS. 103, 104.

FOR SUBFLOORBEAM DETAILS SEE SHEET NO. 103.

FOR PROPOSED DECK SEE SHEET NO. 115.

FOR PROPOSED BRIDGE RAILING SEE SHEET NOS. 127, 128.

ALL BRACING EXCEPT LONGITUDINAL BRACKETS TO BE A36.

ALL BRACING AND CONNECTION PLATES NEW UNLESS NOTED.

PAYMENT FOR REMOVAL OF EXISTING ROADWAY AND SUB-FLOORBEAMS TO BE INCLUDED IN S101 - BRIDGE ROADWAY REMOVAL.

PAYMENT FOR NEW SUB-FLOORBEAMS AND LONGITUDINAL BRACKETS TO BE INCLUDED IN 807(4) - STEEL (A572).

PAYMENT FOR GIRDER AND GIRDER BRACING WORK TO BE INCLUDED IN S103 - APPROACH ROADWAY WIDENING - STRUCTURAL STEEL WORK.

STATE OF LOUISIANA
OFFICE OF HIGHWAYS

U.S. 190 MISSISSIPPI RIVER BRIDGE
AT BATON ROUGE
APPROACH STRUCTURE WIDENING
DETAILS I

MODJESKI AND MASTERS
CONSULTING ENGINEERS

DATE: AUG. 1955 BY: [Signature] SCALE: AS NOTED (DWG. NO. 102)
 DRAWN BY: [Signature] CHKD. BY: H.R.R. IN CHARGE: D.P.S. APPROVED: W.B.C.

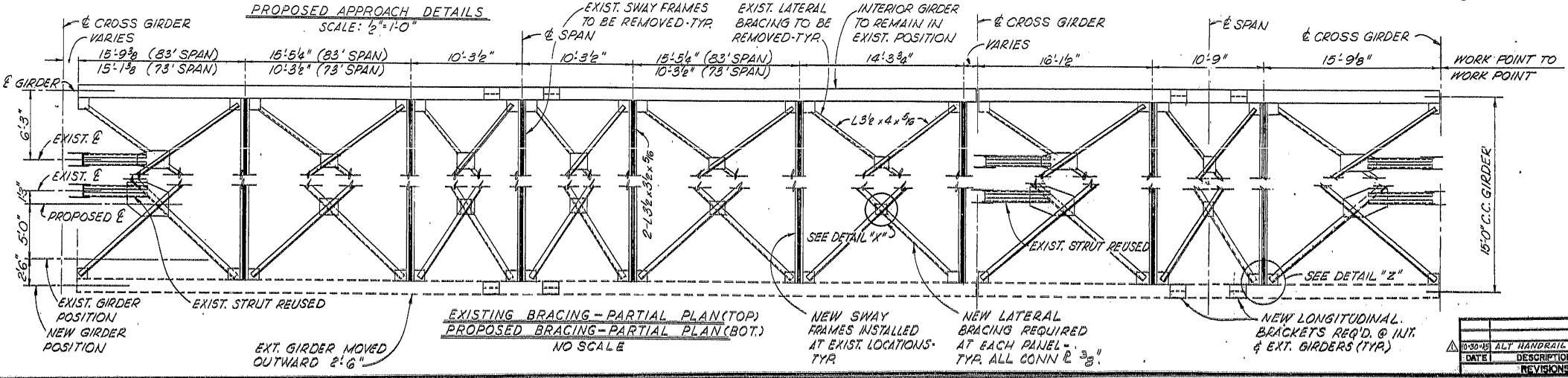

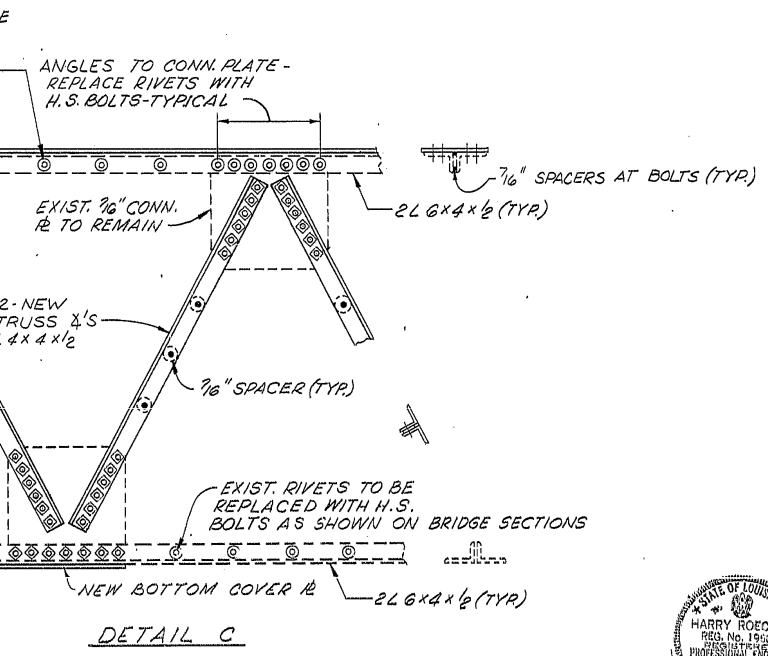
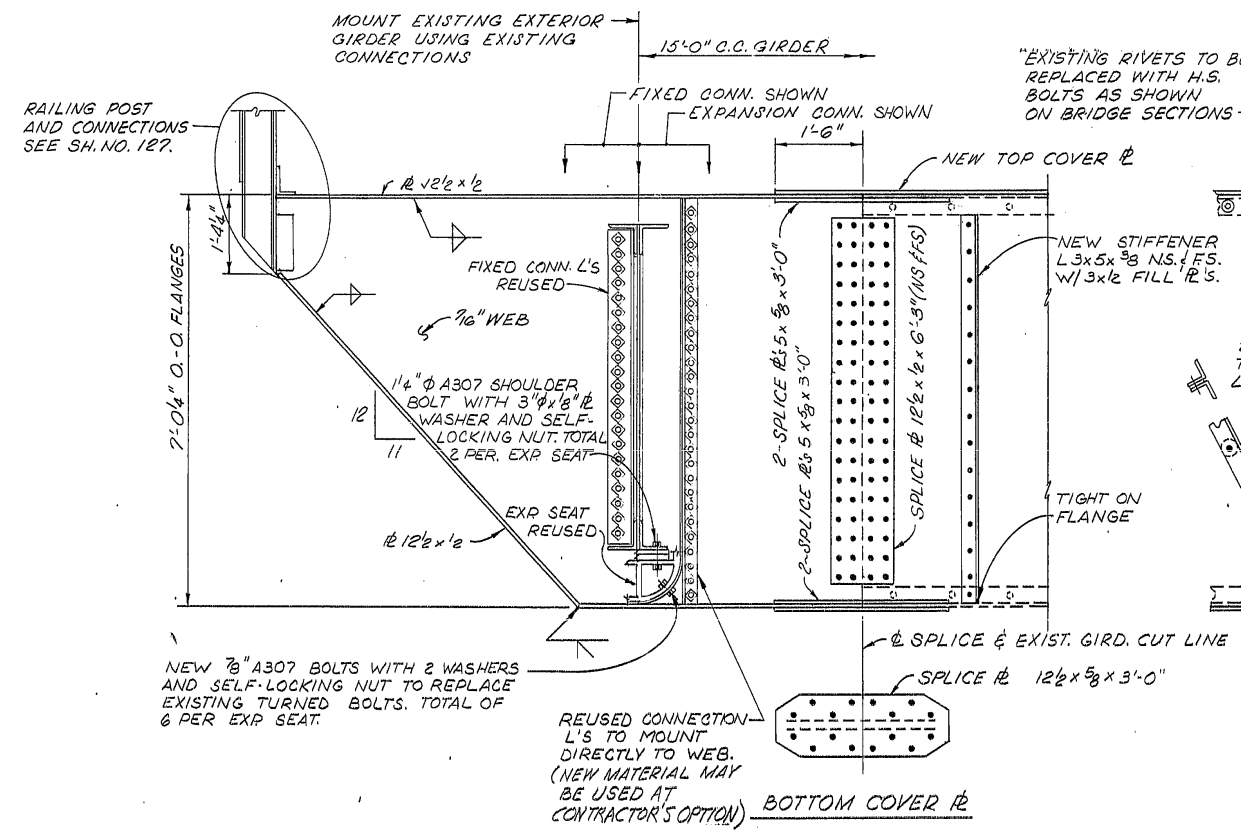
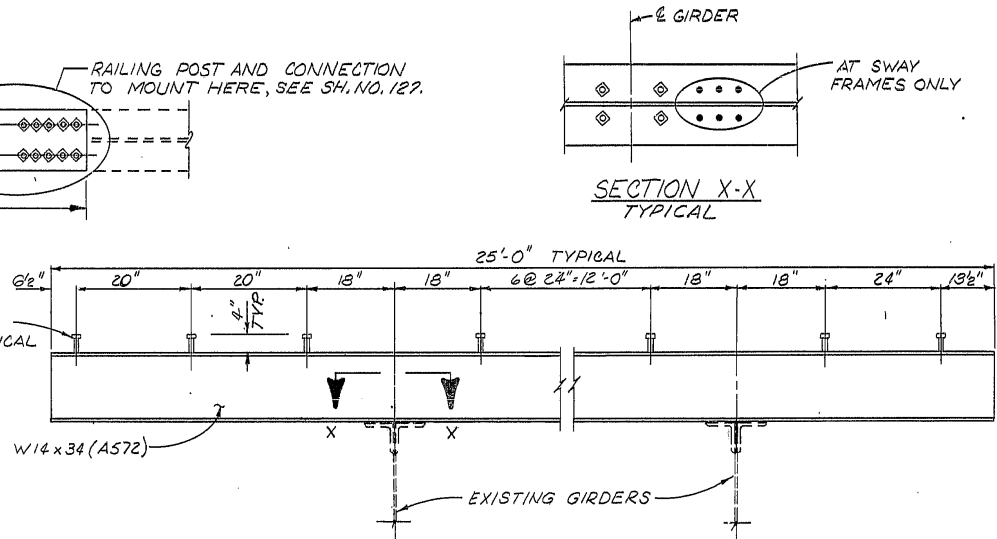
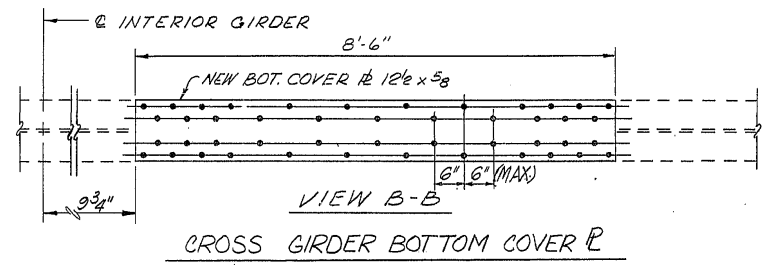
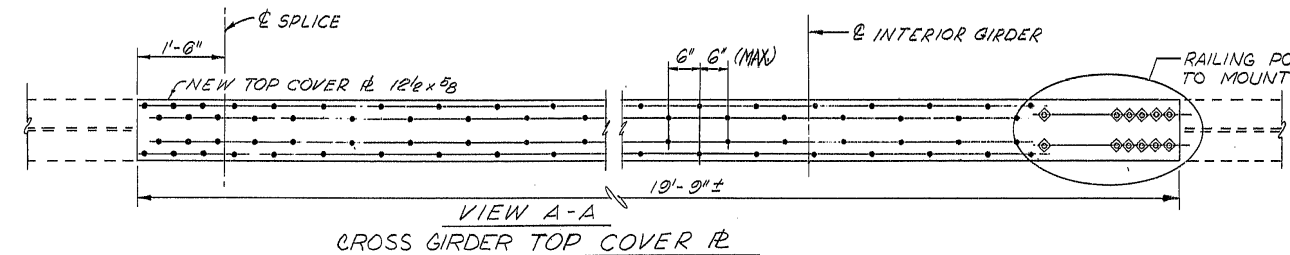

NOTES:

GIRDER REPOSITIONING AND REFURBISHMENT (PAYMENT INCLUDED IN S103 - APPROACH ROADWAY WIDENING - STRUCTURAL STEEL)

REMOVE EXTERIOR GIRDERS AND GIRDER/CROSS GIRDER CONNECTIONS. REPLACE EXPANSION SEAT BOLTS AND EXPANSION ANCHOR BOLTS. SANDBLAST CLEAN SEATS AND GIRDER BEARING FLANGES, INCLUDING THOSE AT ABUTMENTS. SLIDING SURFACES SHALL BE MASKED. PAINT ALL BLASTED METALWORK EXCEPT PAYING SURFACES. INSTALL GIRDERS AND CONNECTIONS AND SEATS. ALL REPOSITIONED GIRDERS MUST ALIGN PROPERLY WITH ADJACENT MEMBERS. ALL GIRDERS AT BENTS 81, 82 AND THE WEST HIGHWAY ABUTMENT SHALL BE CHECKED FOR PROPER POSITION AT EXPANSION SEATS WITH ADJUSTMENTS IN POSITION MADE AS REQUIRED. GIRDERS SHALL NOT BE REPOSITIONED UNTIL ALL CROSS GIRDER COVER PLATING, SPLICING, RIVET REPLACEMENT AND TRUSS ANGLE REPLACEMENT IS FULLY INSTALLED ON THE CONNECTING MEMBERS.

FOR EXPANSION CONNECTION LOCATIONS SEE SHEET NOS. 120, 125, 126.

FOR GENERAL WORK DESCRIPTIONS AND VIEW REFERENCES SEE BRIDGE SECTIONS SHEET NO. 101.

FOR GENERAL NOTES SEE SHEET NO. 3.

ALL NEW MATERIAL TO BE A56 UNLESS NOTED.

- KEY
- EXISTING RIVET
 - ◊ HIGH STRENGTH BOLT CONNECTING NEW MATERIAL TO EXISTING. NEW HOLE MUST MATCH EXISTING.
 - ⊙ EXISTING RIVET REPLACED WITH HIGH STRENGTH BOLT
 - HIGH STRENGTH BOLT IN NEW FASTENER LOCATION



DATE	DESCRIPTION	BY	DATE	AUG. 1955	SCALE	3/4" = 1'-0"	DWG. NO.	108
	REVISIONS		DRAWN BY	JSE	CHECKED BY	H.R.Z.	IN CHARGE	DFS

STATE OF LOUISIANA
OFFICE OF HIGHWAYS
U.S. 190 MISSISSIPPI RIVER BRIDGE
AT BATON ROUGE
APPROACH STRUCTURE WIDENING
DETAILS 2

MODJESKI AND MASTERS
CONSULTING ENGINEERS

F.A.P.	STATE PROJECT	PARISH	SHEET NO.
BHF-03-01(009)	007-10-28	EAST BATON ROUGE	107

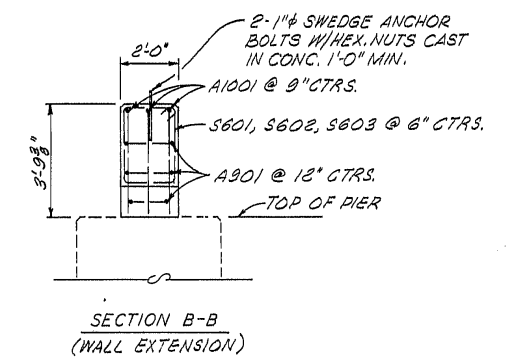
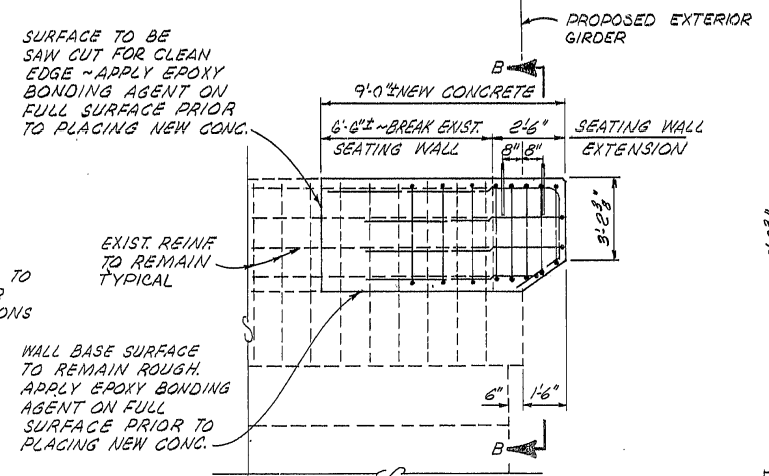
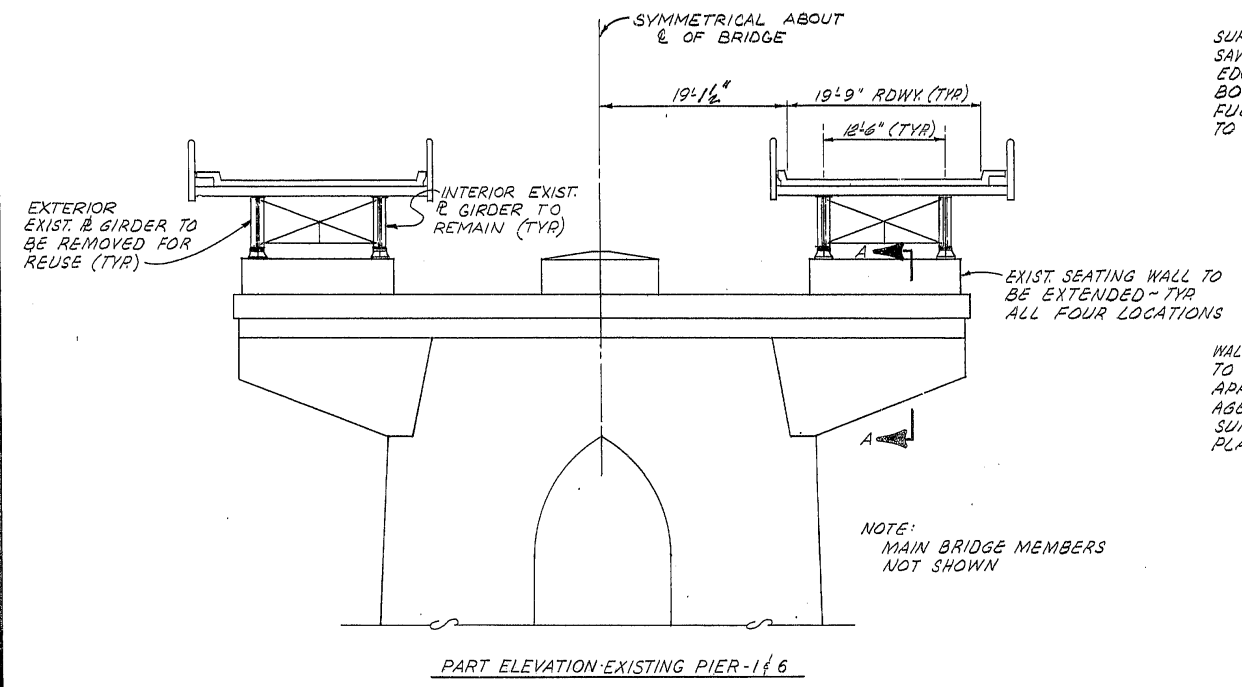

* REINFORCING SCHEDULE

MARK	NO.	SIZE	LENGTH	TYPE	WEIGHT	
S601	1	#6	11'-4"	71	17	
S602	1	#6	11'-3"	72	17	
S603	6	#6	11'-10"	73	107	
A901	3	#9	14'-5"	S1	149	
A1001	3	#10	11'-3"	S2	151	
					TOTAL	439

* ONE PEDESTAL SHOWN - FOUR REQ'D.

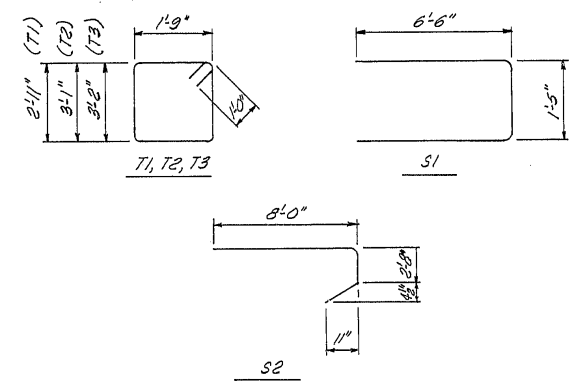
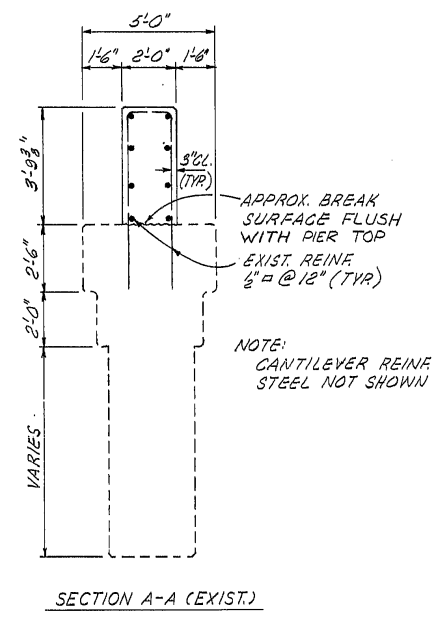
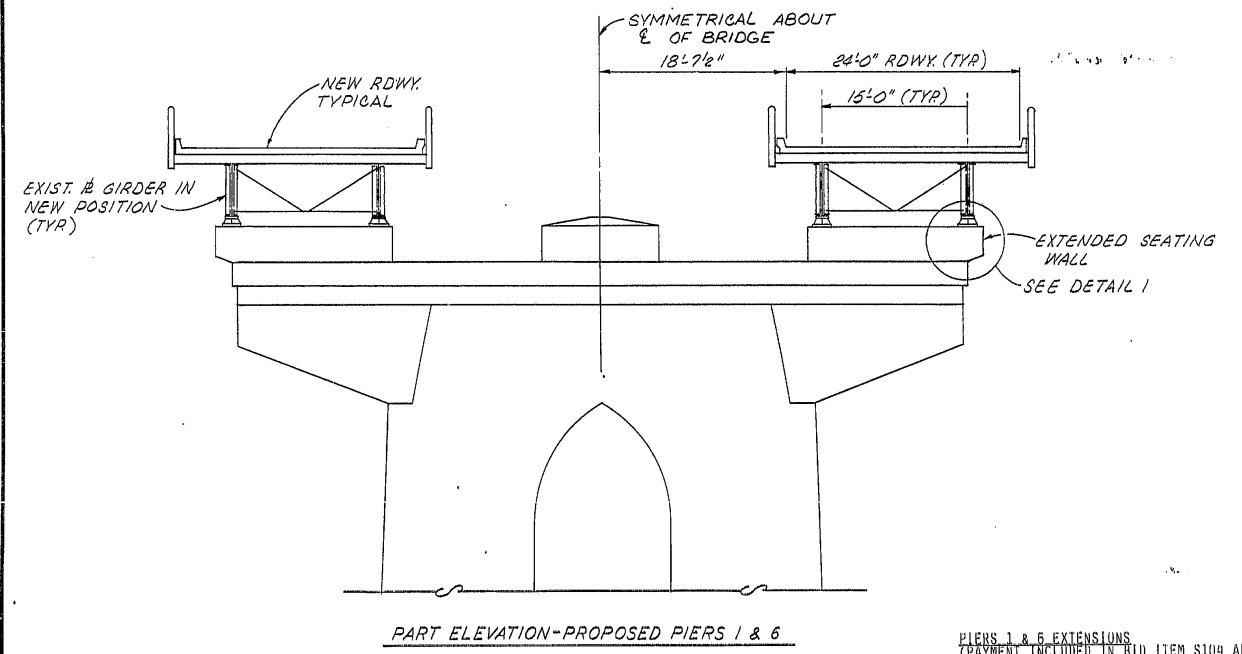

NOTES:
 FOR GENERAL NOTES SEE SHEET NO. 3.
 FOR GENERAL WORK DESCRIPTION OF APPROACH ROADWAY WIDENING SEE SHEET NO. 101.

PIERS 1 & 6 EXTENSIONS
 (PAYMENT INCLUDED IN BID ITEM S104 APPROACH SUBSTRUCTURE WORK)
 FOLLOWING REMOVAL OF EXTERIOR GIRDER AND STEEL PEDESTAL (PERFORMED AS PART OF APPROACH ROADWAY WIDENING) REMOVE SECTION OF EXISTING SEATING WALL AND REPLACE AS SHOWN. CARE SHALL BE TAKEN TO PREVENT DAMAGE TO EXISTING REINFORCING STEEL.
 WALL EXTENSION TO BE PERFORMED AT 4 LOCATIONS TOTAL.

STATE OF LOUISIANA
 HARRY RUECKER
 REG. NO. 19684
 PROFESSIONAL ENGINEER
 IN CHARGE

STATE OF LOUISIANA
 OFFICE OF HIGHWAYS
 U.S. 190 MISSISSIPPI RIVER BRIDGE
 AT BATON ROUGE
 APPROACH STRUCTURE WIDENING
 PIERS 1 & 6 EXTENSIONS

DATE	DESCRIPTION	BY	DATE	SCALE	DWG. NO.
			AUG. 1, 1988	NONE	107
DRAWN BY: NLS		CHKD. BY: HRR	IN CHARGE: D.P.S.		APPROVED: WES

FAP	STATE PROJECT	PARRISH	SHEET NO.
BHF-03-01(009)	007-10-28	BATON ROUGE	108

EXISTING BRIDGE RAIL AND CONNECTIONS TO BE REMOVED FOR REUSE. TYPICAL FOR INTERIOR AND EXTERIOR RAILING AT ALL LOCATIONS UNLESS NOTED.

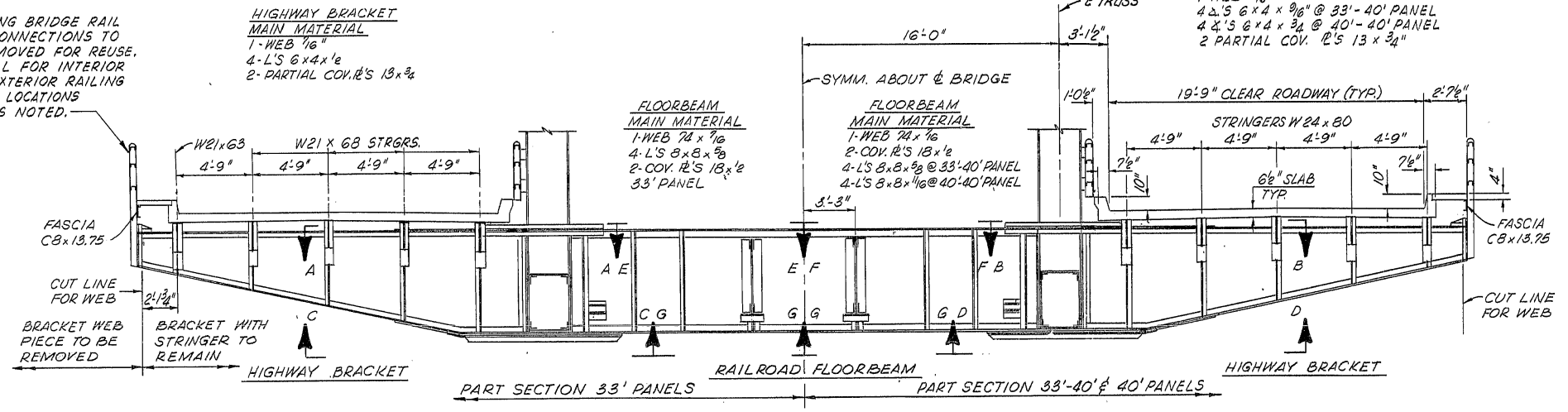

EXISTING BRIDGE SECTION @ FLOORBEAM
SCALE: 1/4" = 1'-0"

RAILROAD DECK NOT SHOWN

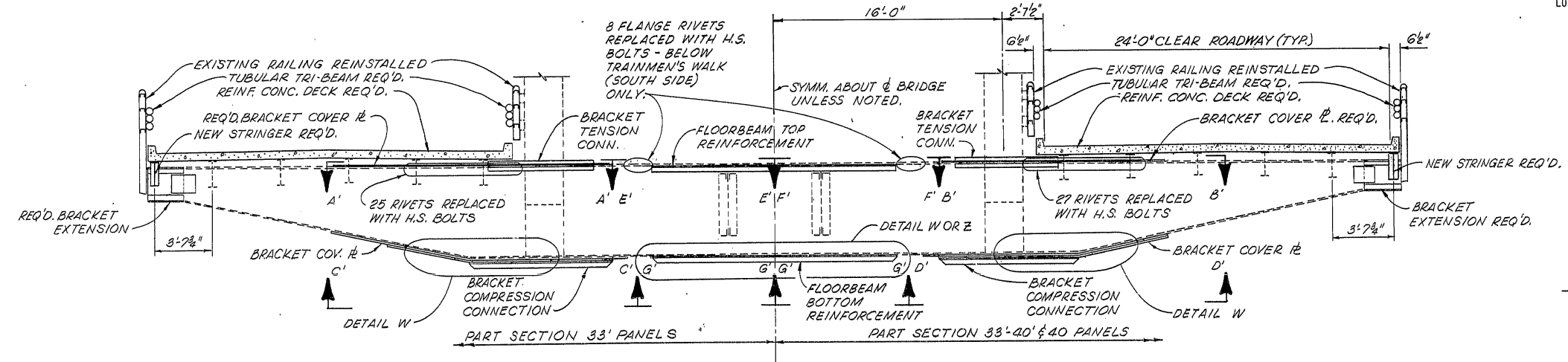

PROPOSED BRIDGE SECTION @ FLOORBEAM
SCALE: 1/4" = 1'-0"

(DASHED LINES DENOTE EXISTING MEMBERS - PRIME SECTION MARKS DENOTE PROPOSED SECTIONS)

- RAILROAD FLOORBEAM MODIFICATIONS (BID ITEM 5201)
- INSTALL FLOORBEAM TOP AND BOTTOM REINFORCEMENT. REPLACE DESIGNATED RIVETS WITH HIGH STRENGTH BOLTS. REAM ALL RIVET HOLES AND REPLACE 1" DIAMETER RIVETS WITH 1-1/8" DIAMETER BOLTS.
- ALL WORK SHALL BE COORDINATED WITH THE RAILROAD AND SHALL BE PERFORMED DURING THE ASSIGNED WORK PERIOD.

MAIN BRIDGE WIDENING
GENERAL WORK DESCRIPTIONS

ROADWAY REMOVAL
(PAYMENT INCLUDED IN BID ITEM S101 - BRIDGE ROADWAY REMOVAL)

REMOVE REINFORCED CONCRETE ROADWAY DECK, CURBS AND SIDEWALK. REMOVE STEEL ROADWAY DAMS AND JOINTS, ROADWAY SUPPORTS, FASCIA CHANNELS, DRAINS AND DRAIN PIPES. ALL MATERIALS SHALL BE REMOVED IN A CONTROLLED MANNER AND SHALL NOT BE ALLOWED TO FALL FROM THE BRIDGE.

THE COMPLETE WORK DESCRIPTION OF EXISTING ROADWAY REMOVAL INCLUDES THIS WORK, APPROACH ROADWAY WIDENING ROADWAY REMOVAL (SHEET NO. 101), AND APPROACH SLAB REMOVAL (SHEET NO. 5).

BRIDGE RAILING REMOVAL
(PAYMENT INCLUDED IN BID ITEM S102 - BRIDGE RAILING REMOVAL)

REMOVE ALL BRIDGE RAILING PANELS, POSTS, AND POST CONNECTIONS. ALL PIECES SHALL BE MATCH MARKED AS REQUIRED FOR REINSTALLATION OF COMPONENTS.

THE COMPLETE WORK DESCRIPTION OF EXISTING BRIDGE RAIL REMOVAL INCLUDES THIS WORK AND APPROACH ROADWAY WIDENING - BRIDGE RAIL REMOVAL (SHEET NO. 101).

STRUCTURAL STEEL WORK
(BID ITEM S106)

CUT AND EXTEND HIGHWAY BRACKETS AS SHOWN AND MOUNT NEW ROADWAY STRINGER DIAPHRAGMS. STRENGTHEN HIGHWAY BRACKET TENSION AND COMPRESSION CONNECTIONS AND EXTEND BRACKET COVER PLATES. REPLACE DESIGNATED RIVETS WITH HIGH STRENGTH BOLTS.

ALL WORK SHALL BE PERFORMED WITHOUT THE ROADWAY IN PLACE. THE CONTRACTOR SHALL PROVIDE FALSE WORK FOR THE HIGHWAY BRACKETS DURING STRENGTHENINGS. SUPPORT METHODS MUST BE SUBMITTED TO THE ENGINEER FOR REVIEW.

STEEL (A572)
(PAYMENT TO BE MADE UNDER BID ITEM 807(4))

INSTALL NEW ROADWAY STRINGERS AS SHOWN.

TOTAL BID ITEM 807(4) STEEL (A572) INCLUDES THIS WORK AND APPROACH ROADWAY WIDENING-SUB-FLOORBEAMS AND LONGITUDINAL BRACKETS.

- NOTES:**
- FOR GENERAL NOTES SEE SHEET NO. 3.
 - FOR MAIN BRIDGE WIDENING DETAILS AND VIEWS SEE SHEET NOS. 109-112.
 - FOR RAILROAD FLOORBEAM REPAIRS, DETAILS AND VIEWS SEE SHEET NOS. 113, 114.
 - FOR EXISTING BRIDGE RAILING DETAILS SEE APPENDED SHOP DWGS.
 - FOR PROPOSED BRIDGE RAILING SEE SHEET NOS. 127, 128.
 - FOR PROPOSED DECK SEE SHEET NO. 116.



Harry Roebker

STATE OF LOUISIANA
OFFICE OF HIGHWAYS

U.S. 190 MISSISSIPPI RIVER BRIDGE
AT BATON ROUGE
MAIN BRIDGE WIDENING
BRIDGE SECTIONS

MODJESKI AND MASTERS
CONSULTING ENGINEERS

DATE	DESCRIPTION	BY	DATE	SCALE	DWG. NO.
	REVISIONS		AUG. 1988	AS NOTED	108
			DRAWN BY: JDS	CHKD. BY: HRR	IN CHARGE: DFB
				APPROVED: WBC	

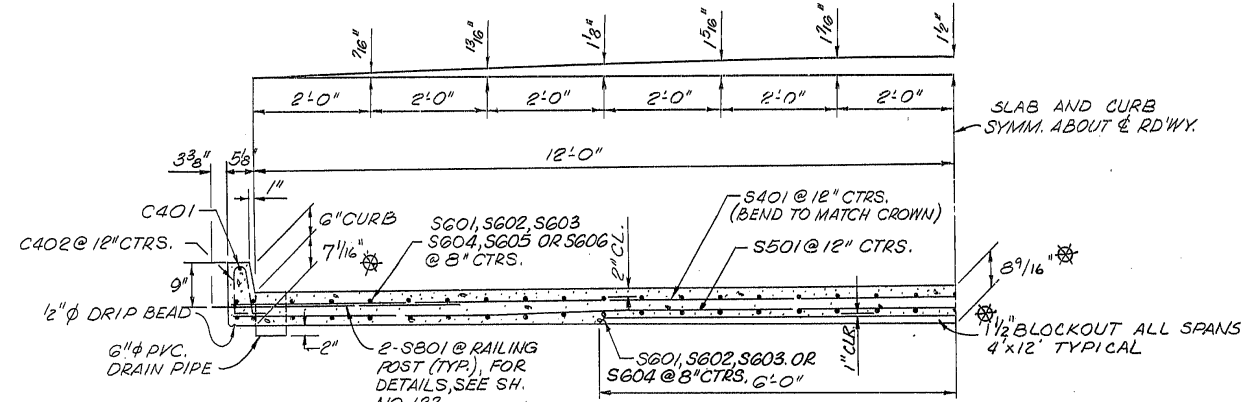

NOTE:
 6 DRAIN PIPES TO BE INSTALLED (3 EACH GUTTER) FOR SPANS OVER 50' AND 4 DRAIN PIPES TO BE INSTALLED (2 EACH GUTTER) FOR SPANS UNDER 50'. OMIT DRAINS OVER EXISTING ROADWAY. FOR LOCATIONS, SEE SH. NOS. 120, 125 & 126

NOTE:
 SUB-FLOORBEAM SHEAR STUDS NOT SHOWN.

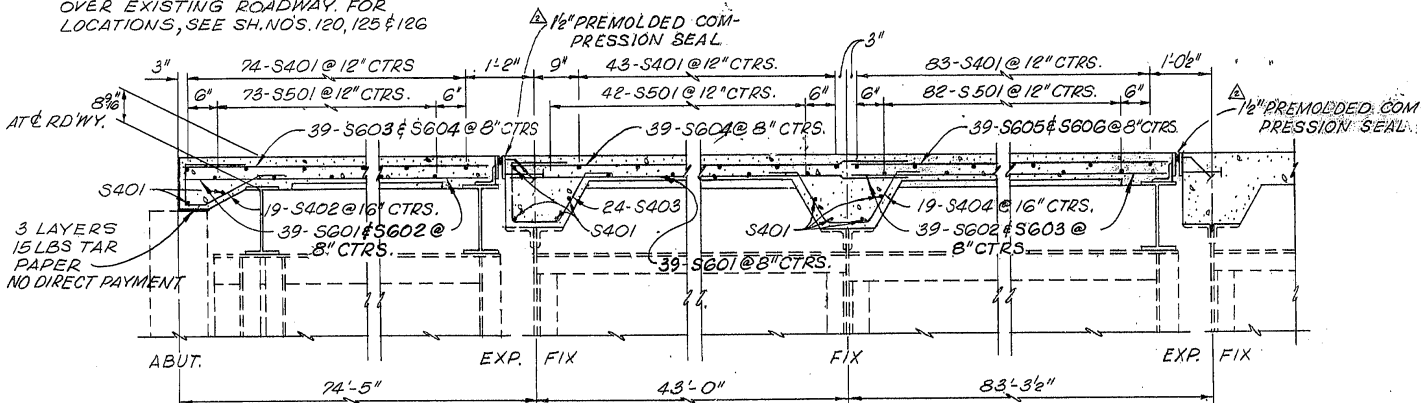

SLAB TYPE (A) 4-REQUIRED
SLAB TYPE (B) 32-REQUIRED

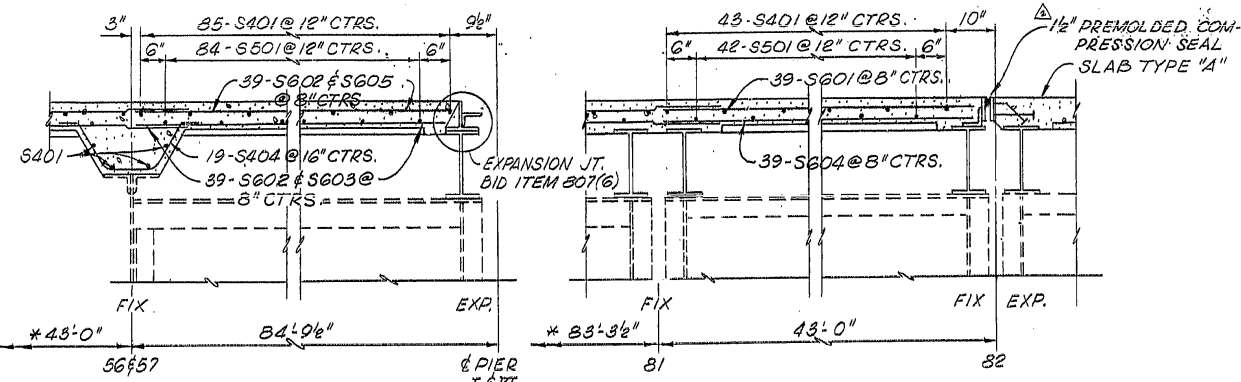

SLAB TYPE (C) 4-REQUIRED
SLAB TYPE (D) 2-REQUIRED

LONGITUDINAL PART-SECTIONS THRU ROADWAY
 SCALE: 3/8" = 1'-0"

* DETAILS FOR THIS SEGMENT SAME AS SHOWN ABOVE FOR SLAB TYPE B

BAR SCHEDULE

MARK	NO.	SIZE	LENGTH	TYPE	WEIGHT
SLAB TYPE (A) 4-REQ'D.					
S401	76	#4	24'-8"	STR.	1252
S402	19	#4	2'-11"	S1	37
C401	4	#4	37'-7"	STR.	100
C402	148	#4	2'-5"	CI	239
S501	73	#5	24'-8"	STR.	1878
S601	39	#6	37'-0"	STR.	2167
S602	39	#6	38'-0"	STR.	2226
S603	39	#6	39'-7"	STR.	2319
S604	39	#6	36'-4"	STR.	2123
S801	32	#8	4'-3"	S4	363
TOTAL:					12,709
					x 4 = 50,836#
SLAB TYPE (B) 32-REQ'D.					
S401	134	#4	24'-8"	STR.	2208
S403	24	#4	3'-11"	S2	63
S404	19	#4	3'-3"	S3	41
C401	6	#4	43'-4"	STR.	174
C402	254	#4	2'-5"	CI	410
S501	124	#5	24'-8"	STR.	3190
S601	39	#6	44'-10"	STR.	2626
S602	39	#6	43'-10"	STR.	2568
S603	39	#6	42'-11"	STR.	2514
S604	39	#6	42'-2"	STR.	2470
S605	39	#6	42'-10"	STR.	2568
S606	39	#6	45'-7"	STR.	2670
S801	52	#8	4'-3"	S4	590
TOTAL:					22,092
					x 32 = 706,944#
SLAB TYPE (C) 4-REQ'D.					
S401	136	#4	24'-8"	STR.	2241
S403	24	#4	3'-11"	S2	63
S404	19	#4	3'-3"	S3	41
C401	6	#4	43'-8"	STR.	175
C402	258	#4	2'-5"	CI	416
S501	126	#5	24'-8"	STR.	3242
S601	39	#6	44'-10"	STR.	2626
S602	78	#6	43'-10"	STR.	5135
S603	39	#6	44'-2"	STR.	2587
S604	39	#6	42'-2"	STR.	2470
S605	39	#6	46'-10"	STR.	2743
S801	52	#8	4'-3"	S4	590
TOTAL:					22,329
					x 4 = 89,316#

FAP	STATE PROJECT	PARISH	SHEET NO.
BHF-03-01(009)	007-10-28	EAST BATON ROUGE	115

MARK	NO.	SIZE	LENGTH	TYPE	WEIGHT
SLAB TYPE (D) -REQ'D.					
S401	126	#4	24'-8"	STR.	2076
C401	6	#4	43'-5"	STR.	174
C402	252	#4	2'-5"	CI	407
S501	124	#5	24'-8"	STR.	3190
S601	39	#6	41'-8"	STR.	2441
S602	39	#6	43'-0"	STR.	2519
S603	39	#6	44'-9"	STR.	2621
S604	39	#6	44'-4"	STR.	2597
S605	39	#6	45'-8"	STR.	2675
S606	39	#6	44'-9"	STR.	2621
S801	52	#8	4'-3"	S4	590
TOTAL:					21,911
					x 2 = 43,822#

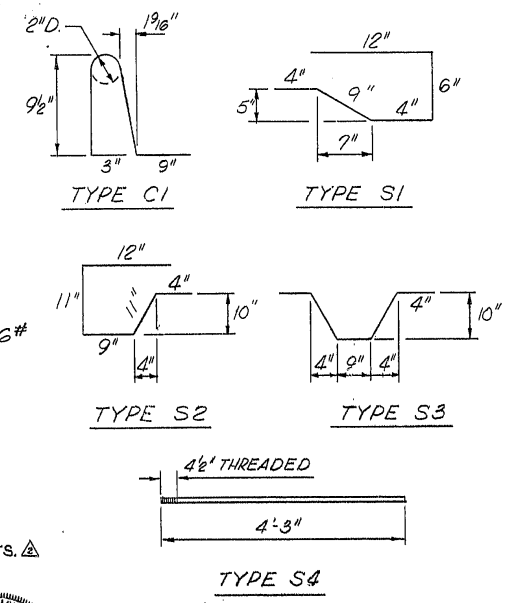

NOTES:
 APPROACH ROADWAY DECK
 INSTALL NEW ROADWAY DECK AS SHOWN.
 CONCRETE - PAYMENT TO BE INCLUDED IN BID ITEM 805(3) CLASS AA CONCRETE.
 REINFORCING STEEL - PAYMENT TO BE INCLUDED IN BID ITEM 806(1) DEFORMED REINFORCING STEEL.
 EXPANSION JOINTS - PAYMENT TO BE INCLUDED IN BID ITEM 805(9) EXPANSION JOINT SEAL.
 TOTAL CLASS AA CONCRETE, DEFORMED REINFORCING STEEL, AND EXP. JTS. CONSIST OF THIS WORK AND MAIN BRIDGE ROADWAY DECK.
 EXPANSION DAMS AT PIERS 1 AND 6 PAYMENT TO BE INCLUDED IN BID ITEM 807(6).
 NO DIRECT PAYMENT FOR PREMOLDED EXPANSION JOINT FILLER.
 FOR GENERAL NOTES SEE SHEET NO. 3.
 FOR ROADWAY DECK PLANS SEE SHEET NOS. 120, 125, 126.
 FOR APPROACH ROADWAY EXPANSION DAMS SEE SHEET NO. 117.
 FOR MAIN BRIDGE ROADWAY DECK SEE SHEET NO. 116.
 EXPANSION GAP MEASUREMENTS AT 70°.
 ALL TYPE S4 BARS SHALL BE GALVANIZED

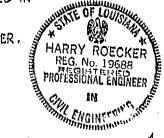

STATE OF LOUISIANA
 OFFICE OF HIGHWAYS
 U.S. 190 MISSISSIPPI RIVER BRIDGE
 AT BATON ROUGE
 APPROACH ROADWAY WIDENING
 TYPICAL SLAB REINFORCING DETAILS

MODJESKI AND MASTERS
 CONSULTING ENGINEERS
 DATE: AUG. 1988 SCALE: AS NOTED DWG. NO. 115
 DRAWN BY: JCS CHECKED BY: WBC IN CHARGE: CFS APPROVED: WBC

F.A.R.	STATE PROJECT	PARISH	SHEET NO.
BW03-01(009)	007-10-28	EAST BATON ROUGE	118

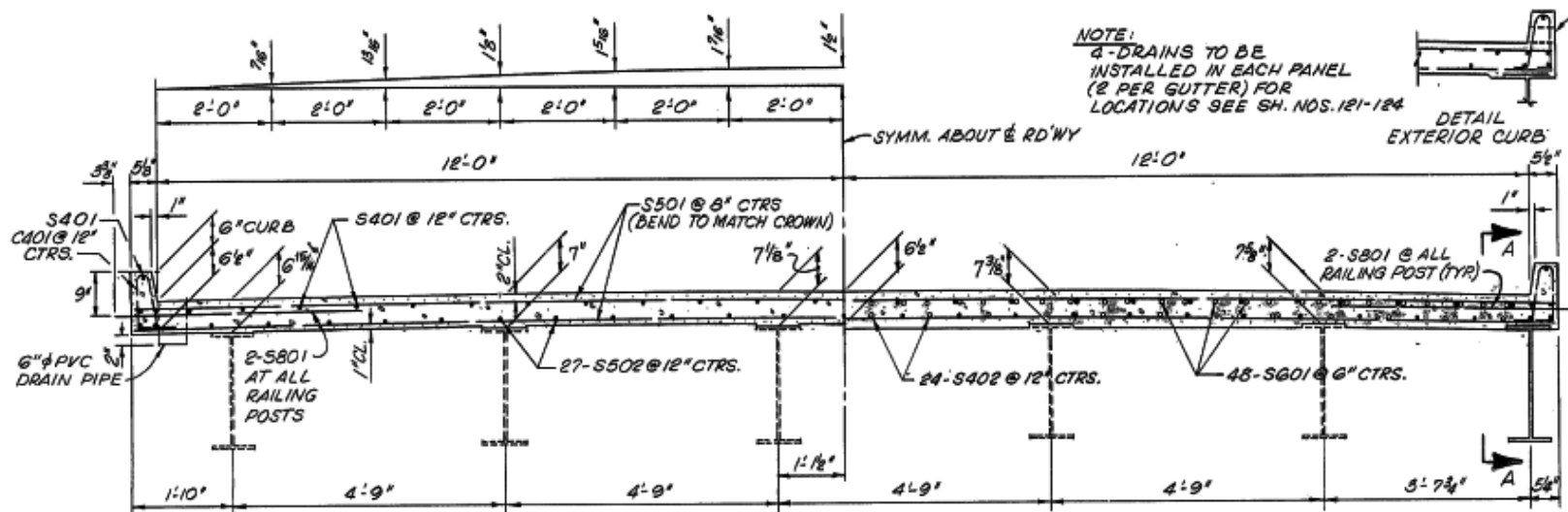

NOTE:
STRINGER ELEVATIONS AND STRINGER HAUCHES VARY.

TYPICAL SECTION THRU ROADWAY
SCALE: 1/4" = 1'-0"

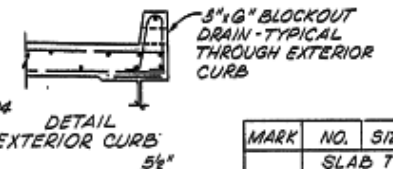

BAR SCHEDULE

MARK	NO.	SIZE	LENGTH	TYPE	WEIGHT
SLAB TYPE (E) 4-REQ'D.					
C401	392	#4	2'-5"	C1	633
S401	180	#4	38'-0"	STR.	4088
S501	584	#5	24'-8"	STR.	15025
S502	162	#5	34'-5"	STR.	5815
S402	24	#4	1'-4"	STR.	32
S403	120	#4	3'-4"	STR.	398
S601	48	#6	2'-8"	STR.	286
S602	120	#6	3'-4"	STR.	894
S801	76	#8	4'-3"	S4	862
				TOTAL	28,038
				x 4 =	112,132#
SLAB TYPE (F) 4-REQ'D.					
C401	194	#4	2'-5"	C1	313
S401	90	#4	38'-8"	STR.	2024
S501	290	#5	24'-8"	STR.	7461
S502	81	#5	34'-0"	STR.	2872
S402	24	#4	1'-4"	STR.	32
S403	48	#4	3'-4"	STR.	159
S601	48	#6	2'-8"	STR.	286
S602	48	#6	3'-4"	STR.	358
S801	36	#8	4'-3"	S4	409
				TOTAL	13,914
				x 4 =	55,656# 2" D.

MARK	NO.	SIZE	LENGTH	TYPE	WEIGHT
SLAB TYPE (G) 4-REQ'D.					
C401	356	#4	2'-5"	C1	575
S401	150	#4	37'-1"	STR.	3716
S501	534	#5	24'-8"	STR.	13738
S502	135	#5	37'-6"	STR.	5280
S402	24	#4	1'-4"	STR.	32
S403	96	#4	3'-4"	STR.	318
S601	48	#6	2'-8"	STR.	286
S602	96	#6	3'-4"	STR.	715
S801	72	#8	4'-8"	S4	817
				TOTAL	25,477
				x 4 =	101,908#

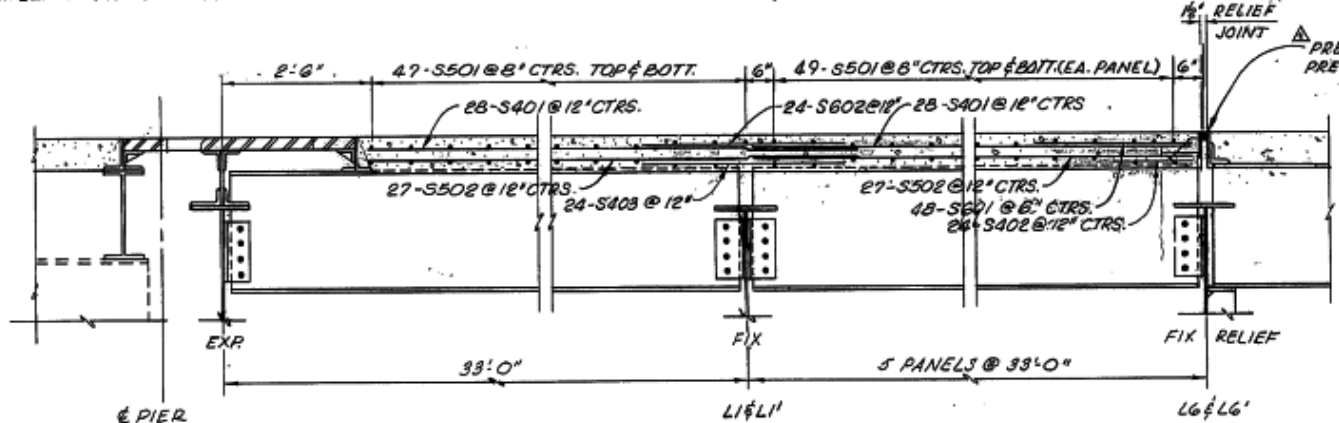

NOTE:
STRINGER SHEAR STUDS NOT SHOWN.

SLAB TYPE (E)
4-REQUIRED

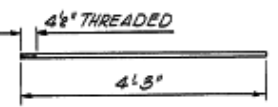
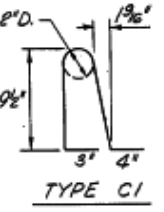

NOTES:
MAIN BRIDGE ROADWAY DECK
INSTALL NEW ROADWAY DECK AS SHOWN.
CONCRETE - PAYMENT TO BE INCLUDED IN BID ITEM 805(3) CLASS AA CONCRETE.
REINFORCING STEEL - PAYMENT TO BE INCLUDED IN BID ITEM 805(1) DEFORMED REINFORCING STEEL.
RELIEF JOINTS - PAYMENT TO BE INCLUDED IN BID ITEM 805(6) EXPANSION JOINT SEAL.
TOTAL CLASS AA CONCRETE, DEFORMED REINFORCING STEEL, AND RELIEF JTS. CONSIST OF THIS WORK AND APPROACH ROADWAY DECK.
ALL EXPANSION JOINT DIMENSIONS AT 70".
FOR GENERAL NOTES SEE SHEET NO. 3.
FOR ROADWAY DECK PLANS SEE SHEET NOS. 121, 122, 123, 124.
FOR MAIN BRIDGE ROADWAY EXPANSION JOINTS SEE SHEET NOS. 118, 119.
FOR APPROACH ROADWAY DECK SEE SHEET NO. 115.
FOR PREFORMED COMPRESSION SEAL SEE APPENDIX STATE STANDARD.
NO DIRECT PAYMENT FOR PREFORMED JT. FILLER.
ALL TYPE S4 BARS SHALL BE GALVANIZED.

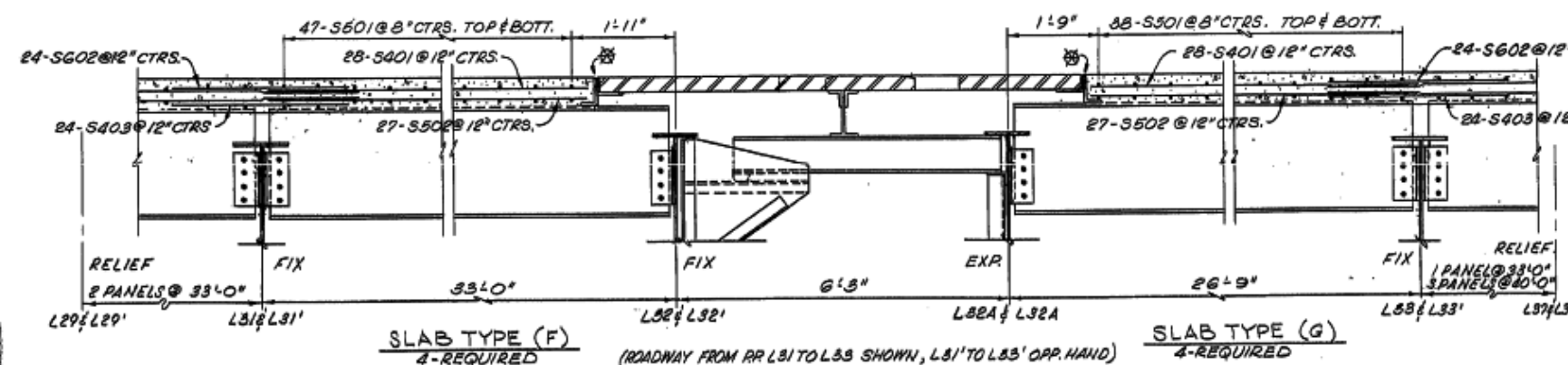

SLAB TYPE (F)
4-REQUIRED

SLAB TYPE (G)
4-REQUIRED

SECTIONS A-A
SCALE: 1/4" = 1'-0"



Harry Roush

STATE OF LOUISIANA
OFFICE OF HIGHWAYS
U.S. 190 MISSISSIPPI RIVER BRIDGE
AT BATON ROUGE
MAIN BRIDGE ROADWAY WIDENING
TYPICAL SLAB REINFORCING DETAILS

MODJESKI AND MASTERS
CONSULTING ENGINEERS

DATE: AUG. 1985 SCALE: AS NOTED (ORIGINAL) 118
DRAWN BY: JDS CHG. BY: WBC IN CHARGE: DFG APPROVED: WBC

F.A.R.	STATE PROJECT	PARISH	SHEET NO.
BHF-03-01000	007-10-20	BATON ROUGE	127

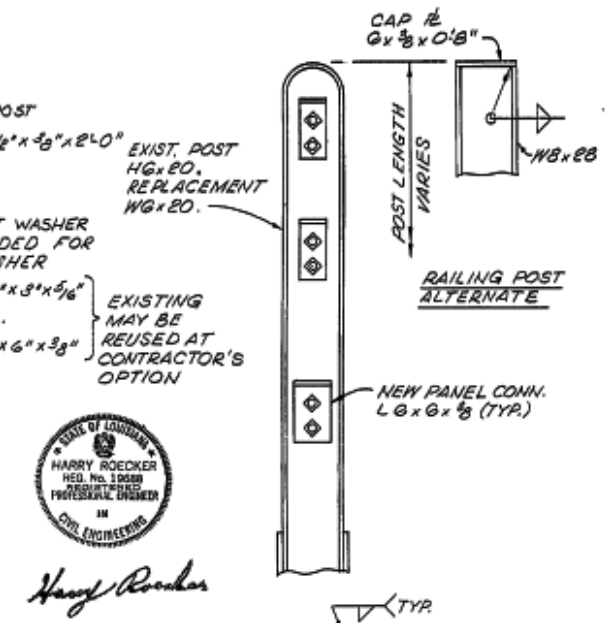
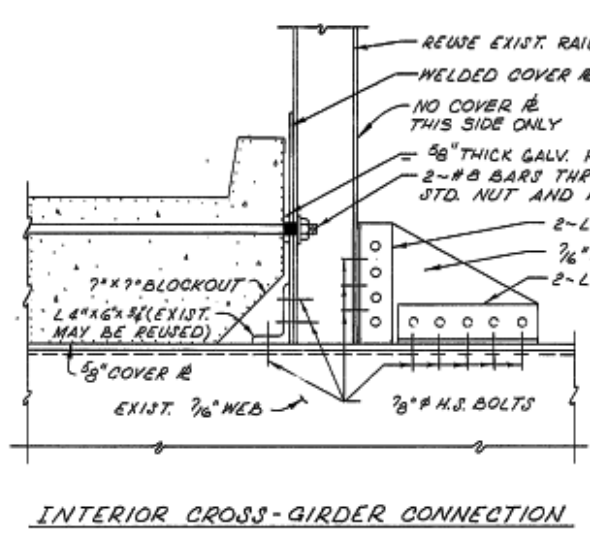
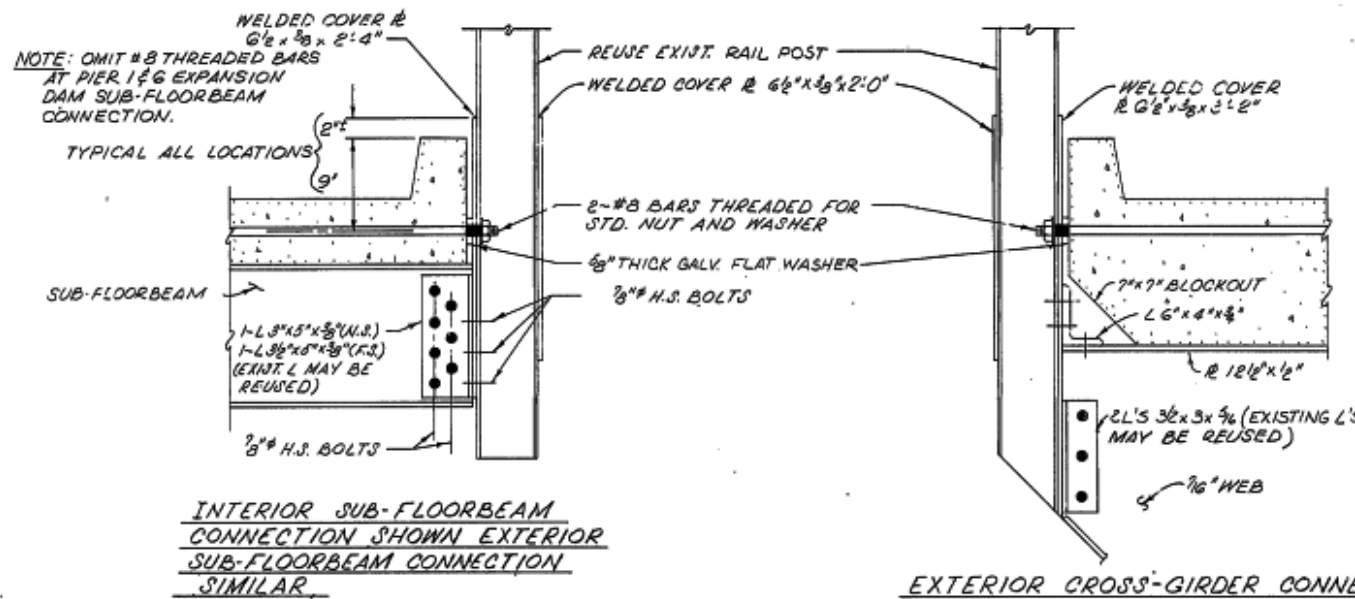

Harry Roedker

EXTERIOR CROSS-GIRDER CONNECTION
APPROACH BRIDGERAIL POST CONNECTION DETAILS

- KEY
- EXISTING RIVET
 - ⊕ HIGH STRENGTH BOLT CONNECTING NEW MATERIAL TO EXISTING. NEW HOLE MUST MATCH EXISTING.
 - ⊙ EXISTING RIVET REPLACED WITH HIGH STRENGTH BOLT
 - HIGH STRENGTH BOLT IN NEW FASTENER LOCATION

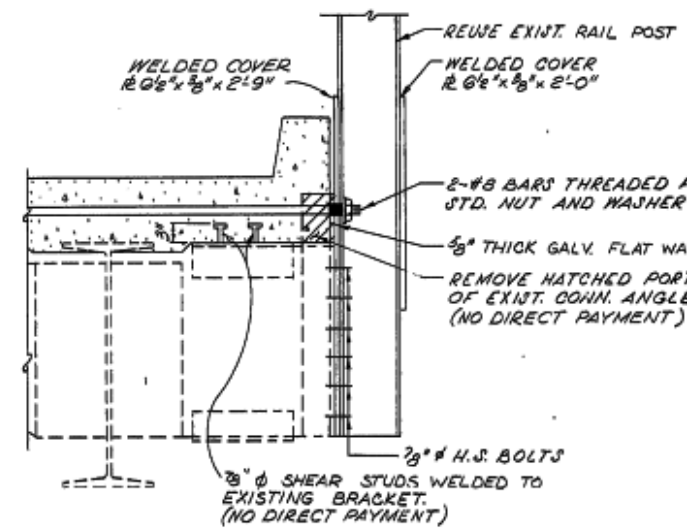
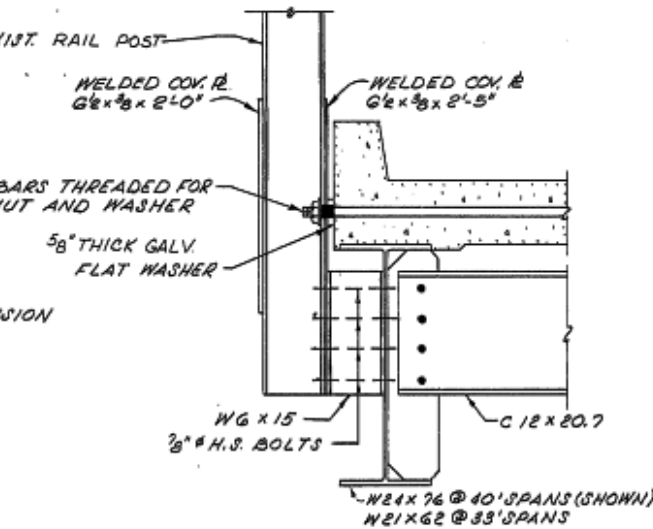
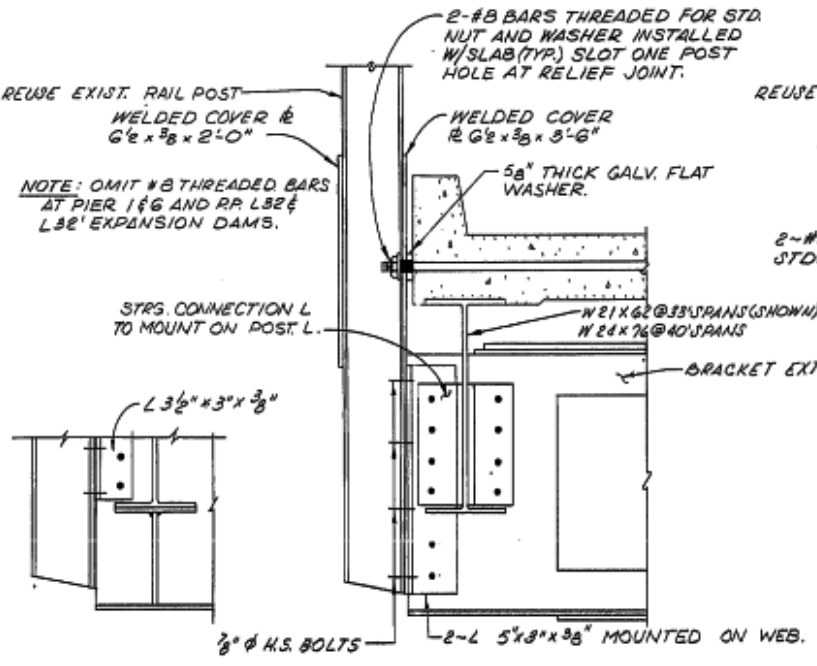

- NOTES:
- EXISTING BRIDGE RAILING
 - PERFORM REHABILITATION OF EXISTING BRIDGE RAILING SYSTEM AS SHOWN. WORK SHALL ENTAIL AND BE CATEGORIZED AS THE FOLLOWING:
 - SI07A REPLACEMENT POST - REPLACE DAMAGED BRIDGE RAIL POSTS WITH NEW POST AS SHOWN. POST IS TO MATCH EXISTING.
 - SI07B REPLACEMENT PANEL - REPLACE DAMAGED BRIDGE RAIL PANELS WITH NEW PANELS. PANELS TO MATCH EXISTING.
 - SI07C REFINISHING AND INSTALLATION - REMOVE EXISTING CONNECTION PANELS FROM POSTS AND RAILING PANELS. BLAST CLEAN ALL POSTS, RAILING PANELS, AND CONNECTIONS TO BE REUSED. COVER PLATE EXISTING POSTS. ASSEMBLE, PAINT AND INSTALL BRIDGE RAIL AS SHOWN.
 - AT HIS OPTION, THE CONTRACTOR MAY REPLACE ALL EXISTING POSTS WITH A NEW POST AS SHOWN.
- FOR GENERAL NOTES SEE SHEET NO. 5.
- FOR EXISTING BRIDGE RAIL DETAILS SEE ORIGINAL SHOP DRAWINGS.
- FOR RAILING AND PANEL REPLACEMENT LOCATIONS SEE SHEET NOS. 120-126.
- FOR #8 THREADED BARS SEE SHEET NOS. 115, 116.
- FOR EXISTING BRIDGE RAIL REMOVAL AND BRIDGE SECTIONS SEE SHEET NOS. 101, 108.
- ALL NEW MEMBERS AS6 UNLESS NOTED.

RELIEF STRINGER CONN. FIXED STRINGER CONN.
EXTERIOR HIGHWAY BRACKET CONN.

MAIN BRIDGE BRIDGERAIL POST CONNECTION DETAILS

NOTE:
POST CONN. TO TRUSS MEMBERS NOT SHOWN, NO COVER PLATES REQ'D., PANEL CONN. L'S TO BE REPLACED. POST MUST BE REMOVED FOR CLEANING AND PAINTING. SEE ORIGINAL SHOP DRAWINGS FOR DETAILS.

STATE OF LOUISIANA
OFFICE OF HIGHWAYS
U. S. 190 MISSISSIPPI RIVER BRIDGE
AT BATON ROUGE
BRIDGE RAILING POST CONNECTIONS
& DETAILS

DATE	DESCRIPTION	BY	CHECKED	SCALE	DATE	APPROVED

MODJESKI AND MASTERS
CONSULTING ENGINEERS

FAP	STATE PROJECT	PARISH	SHEET NO.
BHF-03-01008	007-10-28	BATON ROUGE	128

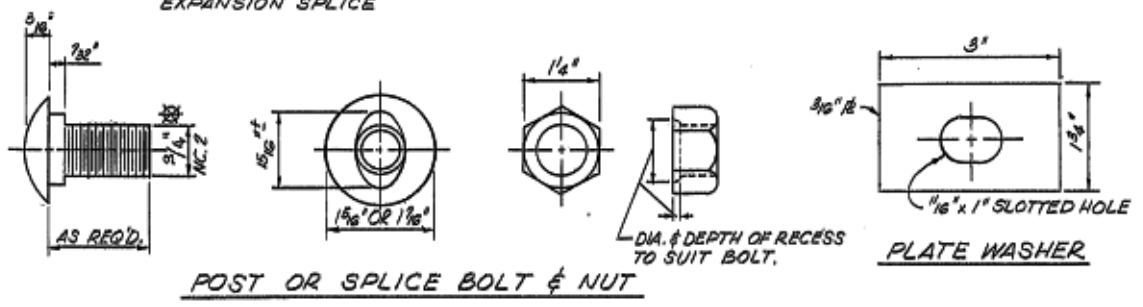
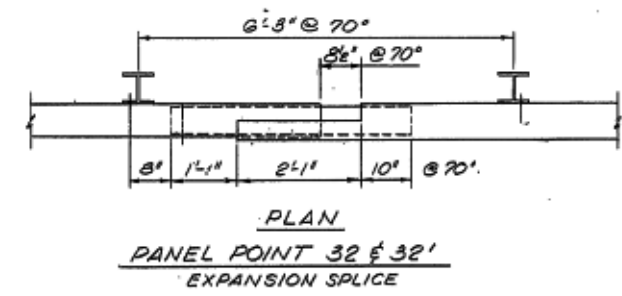
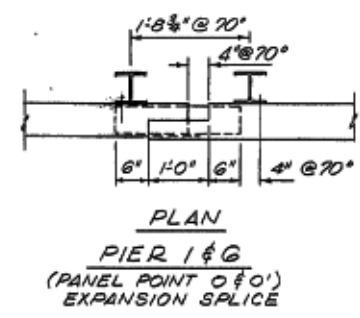
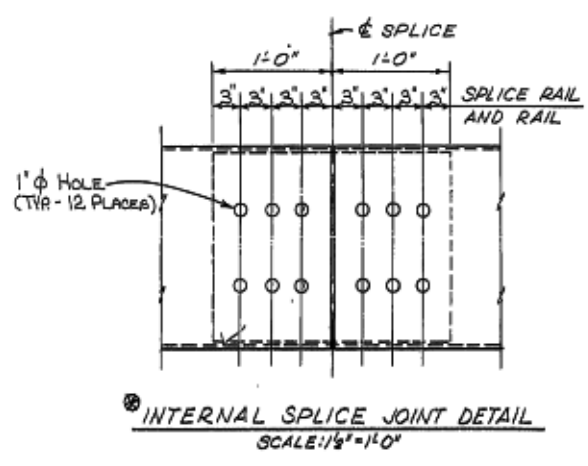
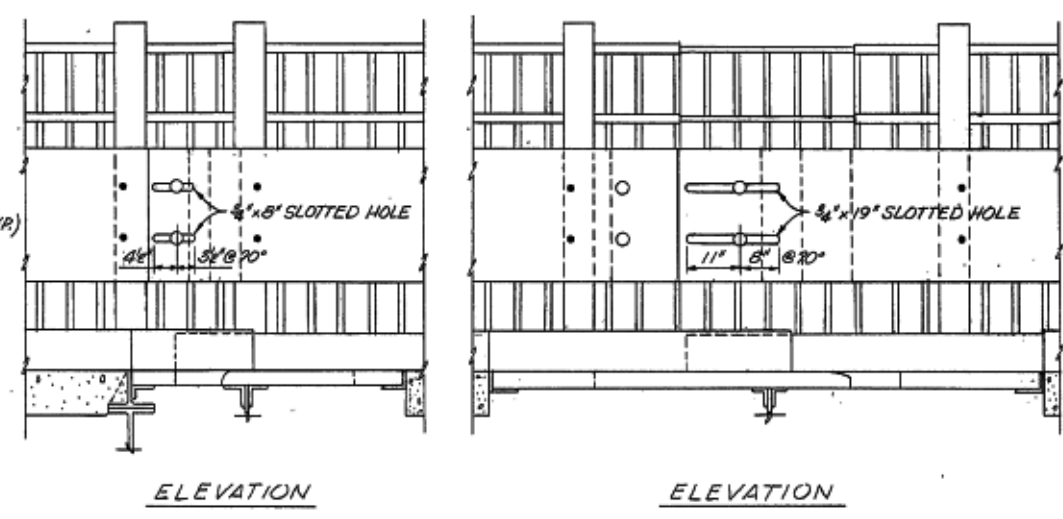
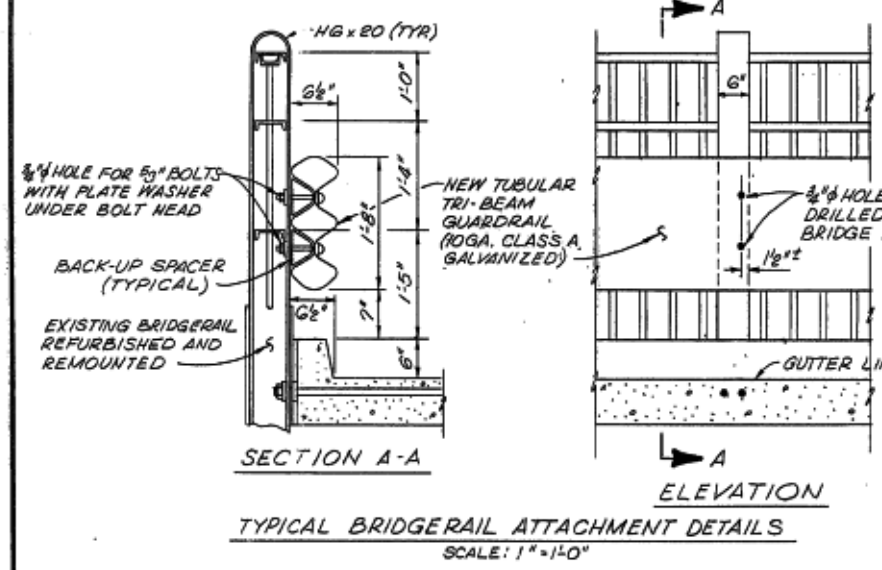
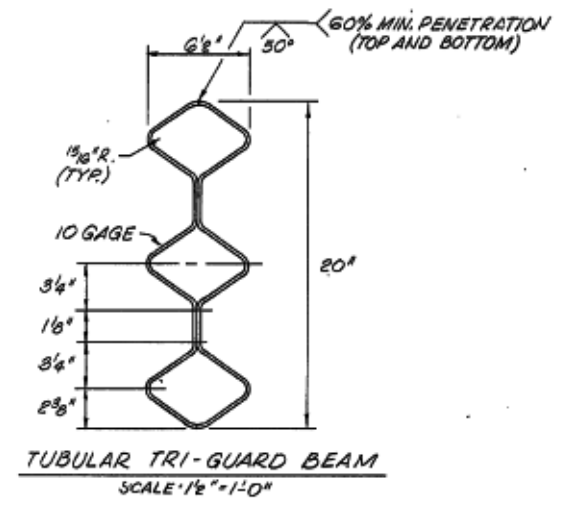
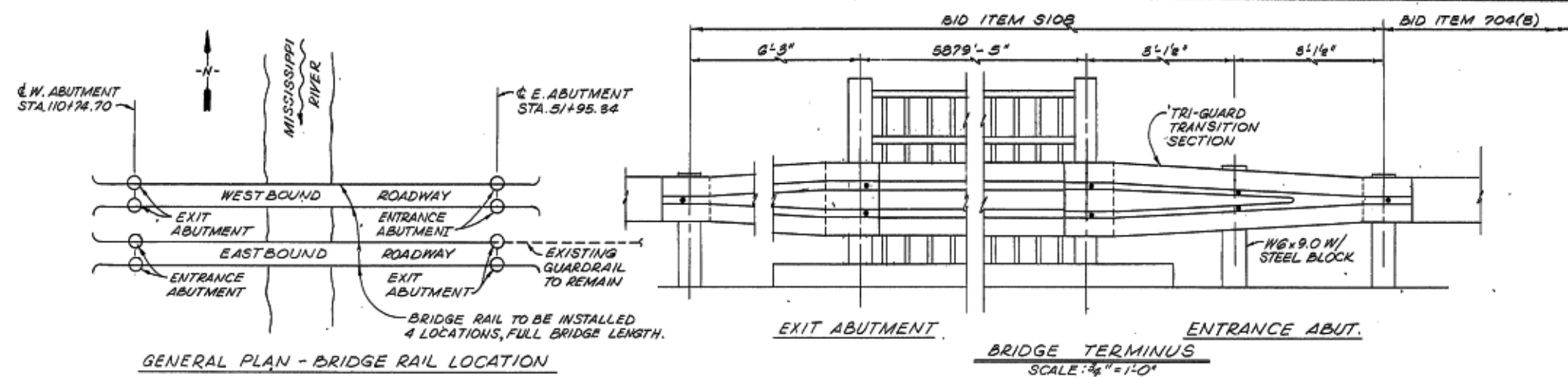

NOTES:
 TUBULAR BRIDGE RAIL (BID ITEM 5108)
 INSTALL TUBULAR TRI-BEAM BRIDGE RAIL AS SHOWN. TUBULAR BEAM AND ALL HARDWARE TO BE GALVANIZED.

FOR GENERAL NOTES SEE SHEET NO. 3.
 FOR EXISTING BRIDGE MAILING SEE SHEET NO. 127, 401 & 402. Δ
 FOR OFF STRUCTURE GUARDRAIL SEE SHEET NO. 5.
 FOR ABUTMENTS SEE SHEET NO. 106.
 EXPANSION SPICE LAPS TO BE IN DIRECTION OF TRAFFIC.



Harry Hoeker

STATE OF LOUISIANA
 OFFICE OF HIGHWAYS
 U.S. 190 MISSISSIPPI RIVER BRIDGE
 AT BATON ROUGE
 BRIDGE RAILING DETAILS

DATE	DESCRIPTION	BY	APPROVED

MODJESKI AND MASTERS
 CONSULTING ENGINEERS

43'-0" SPANS
GIRDER SECTION - Carbon Steel
 Top Flange - 2-# 6 x 1 1/2"
 Web - 65 x 1/2"
 Bottom Flange - 2-# 6 x 1 1/2"
 End Rivet Pitch - 5'-0"

83'-3 1/2" SPANS
GIRDER SECTION - Silicon Steel
 Top Flange - 2-# 6 x 1 1/2" and 2 cover Bx
 Web - 65 x 1/2"
 Bottom Flange - 2-# 6 x 1 1/2" and 2 cover Bx
 End Rivet Pitch - 4'-0" staggered

INT. STIFFENERS
 2-# 2 x 3 1/2"
 Provide Filters

INT. STIFFENERS
 2-# 2 x 3 1/2"
 Provide Filters

All stiffeners shall be finished to bear.

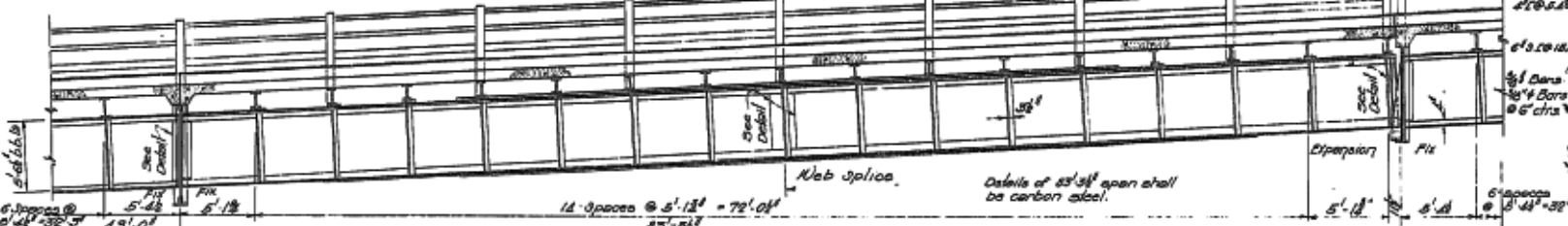

ELEVATION OF ROADWAY GIRDERS

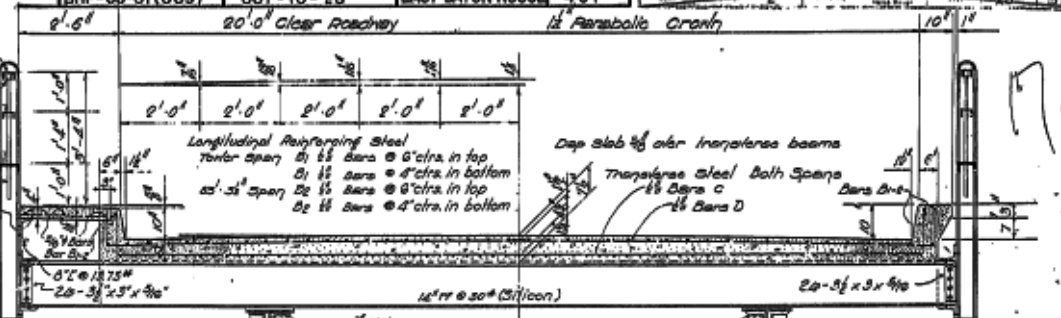

TYPICAL ROADWAY SECTION

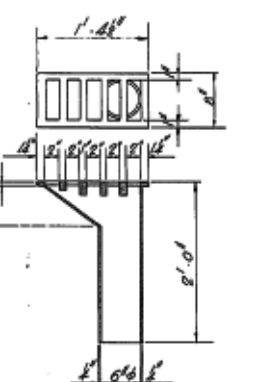

CAST IRON DRAINS

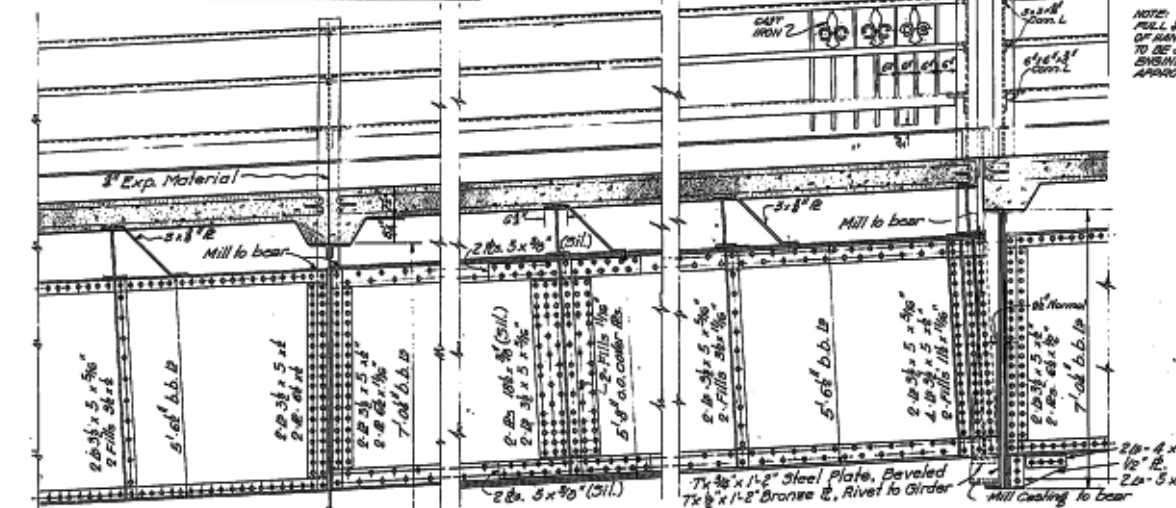

DETAIL AT FIXED END

WEB SPLICE

DETAIL AT EXPANSION END

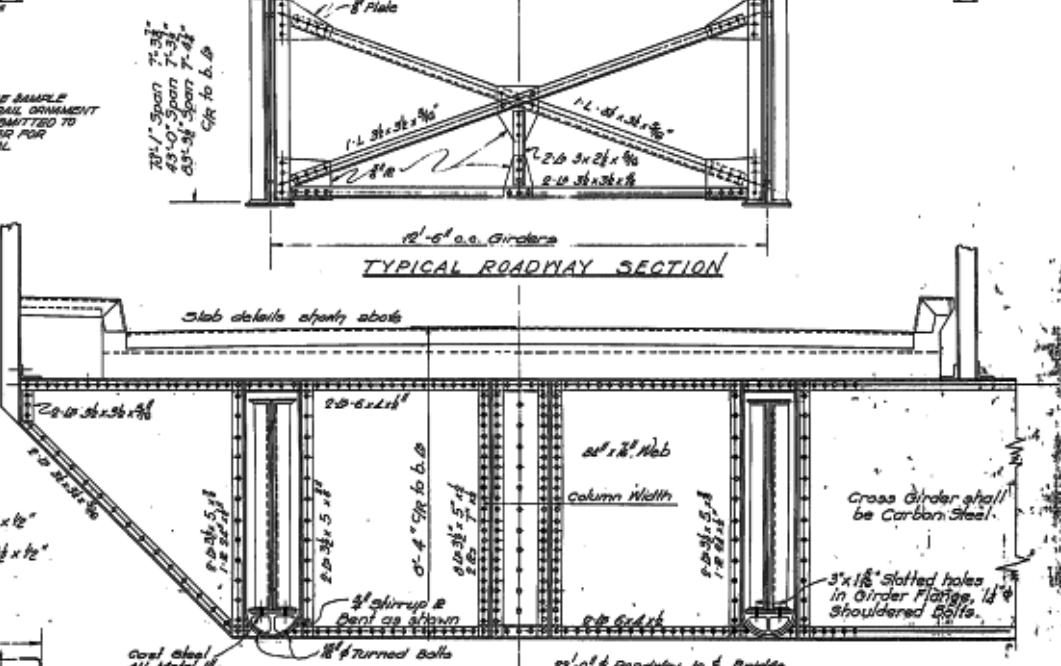

SECTION THRU ROADWAY AT CROSS GIRDER

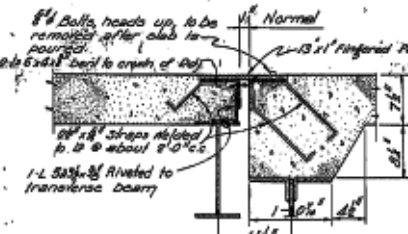

ROADWAY EXPANSION UNIT

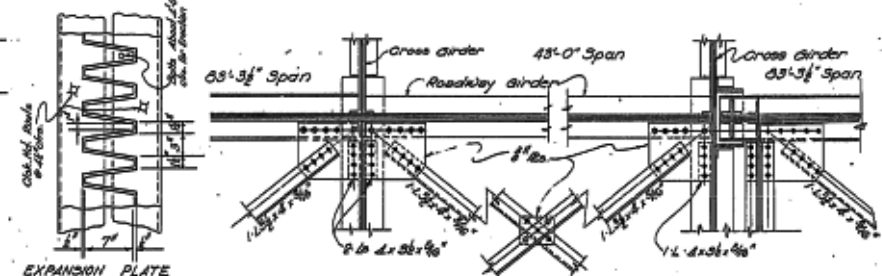

BRACING DETAILS

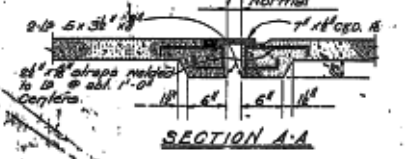

SIDEWALK EXPANSION UNIT

70'-1" SPANS (See Abutment Bent Sheet)
GIRDER SECTION - Silicon Steel
 Top Flange - 2-# 6 x 6 x 3/8" and 1 Cov. @ 14 x 3/8" Full Length
 Web - 65 x 1/2"
 Bottom Flange - 2-# 6 x 6 x 3/8" and 1 Cov. @ 14 x 3/8" 30'-0"

FOR INFORMATIONAL PURPOSES ONLY

[Signature]
 ASSISTANT BRIDGE ENGR.

GENERAL NOTES:
 Live Load - HS 20 Dead Load - Calculated weight of materials plus 15% for future wearing surface.
 All concrete to be class A. Exposed surfaces shall have a rubbed finish. All exposed corners shall be chamfered 3" unless otherwise noted.
 Reinforcing steel dimensions are to centers of bars. All rivets and bolts shall be 3/4" except as noted. All plates shall be continuous. All material shall be carbon steel unless noted. Cost of painting and furnishing O.L. Roadway Girders and Silencers full joint material shall be included in the unit price bid for class A concrete. Cost of furnishing and placing roadway and sidewalk expansion devices, bracing and girders and steel deck shall be paid for as Structural Steel, "A".
 Note: For Quantities of Rein. Steel and Conc. See Sheet

QUANTITIES - ONE ROADWAY

SPAN	Class A Concrete	Rein. Steel	Carbon Steel	Steel Deck
	Cu Yards	Pounds	Pounds	Sq Yards
43'-0"	257	8503	287	4089
83'-3 1/2"	235	10,795	287	4089
70'-1"	517	9,568	28,780	40,878

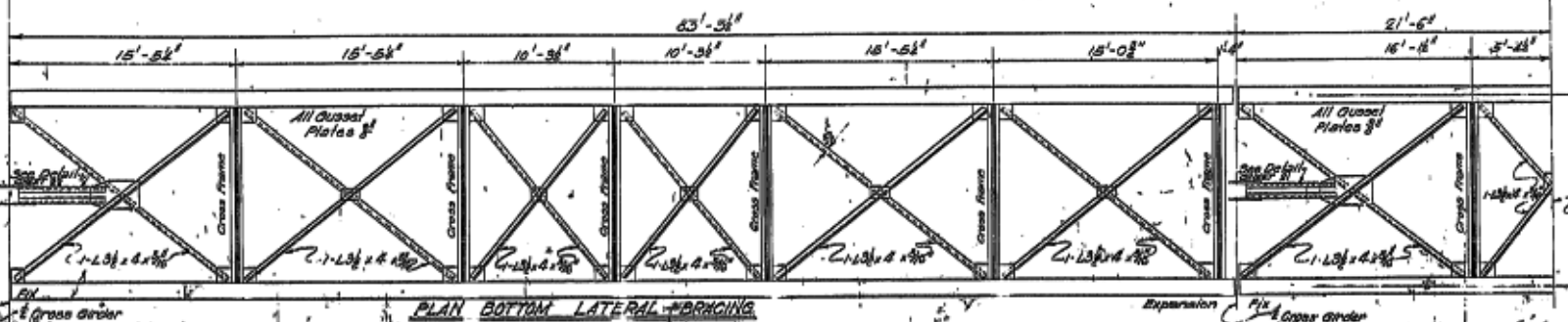

PLAN BOTTOM LATERAL BRACING

DETAILS OF TYPICAL HIGHWAY GIRDER
 Minimum of three girders at each span end.

LOUISIANA HIGHWAY COMMISSION
 BATON ROUGE, LA.

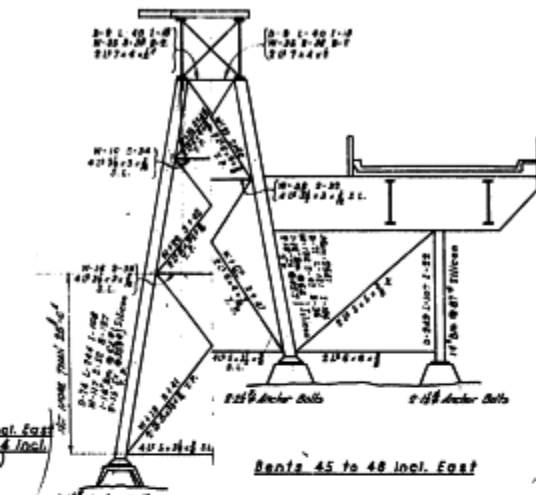
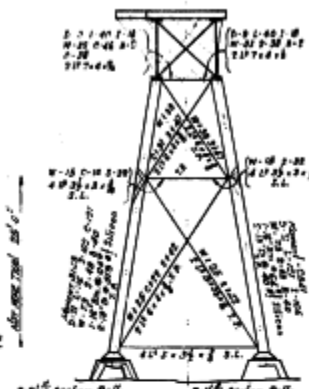
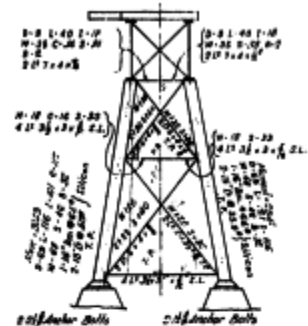
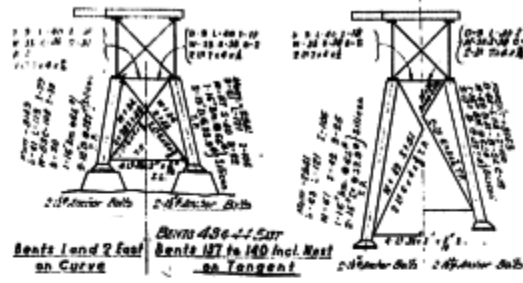

Bents 45 to 48 Incl. East

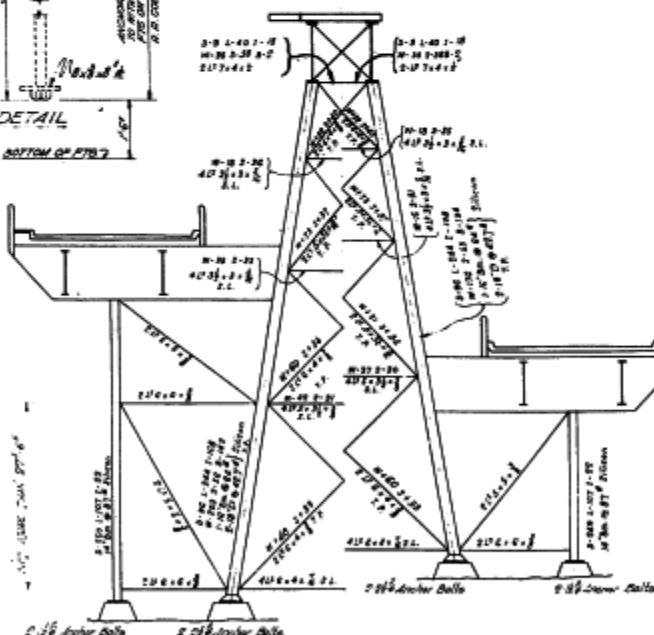
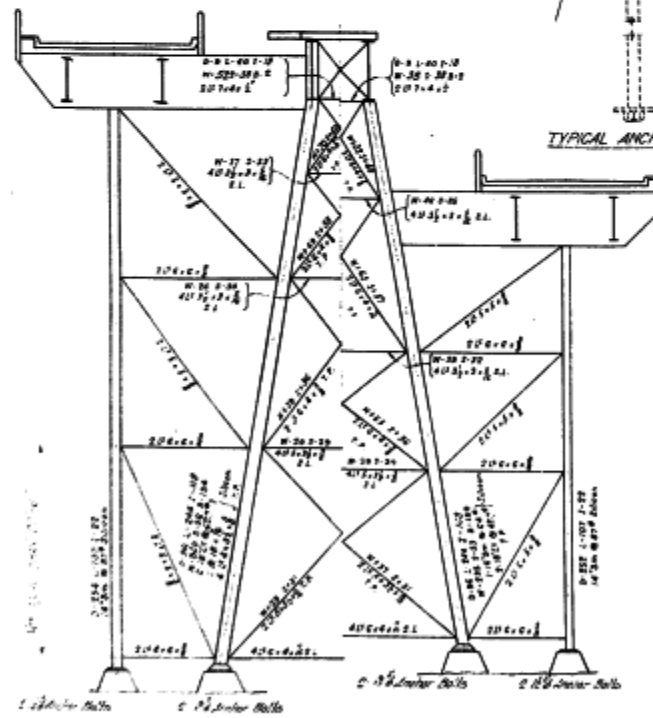
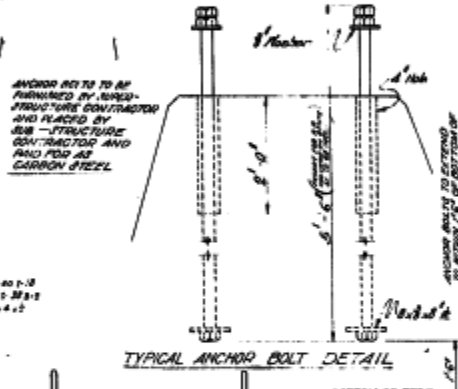
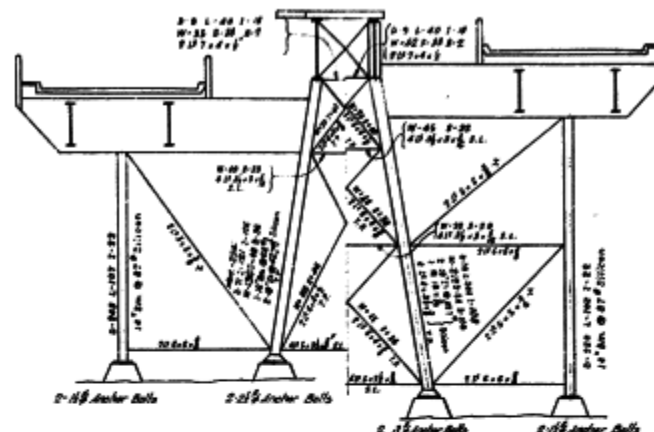

NOTE:
D - Dead Load Stress.
L - Live Load Stress.
I - Impact
W - Stress due to 30° wind on structure and 300' p.f. on live load.
C - Stress due to centrifugal force.
T - Stress due to train (20000') and 2 1/2% shear.
B - Stress due to braking.

GENERAL NOTES:
All material Carbon Steel unless otherwise noted.
Rivets: 3/4"
All Railroad Columns battered 2" in 12' except as noted.

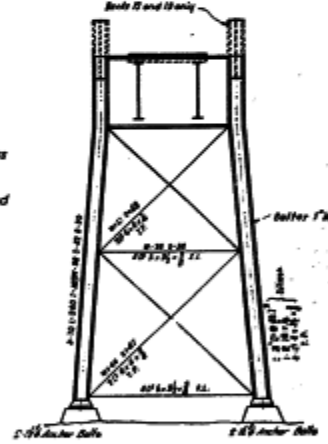
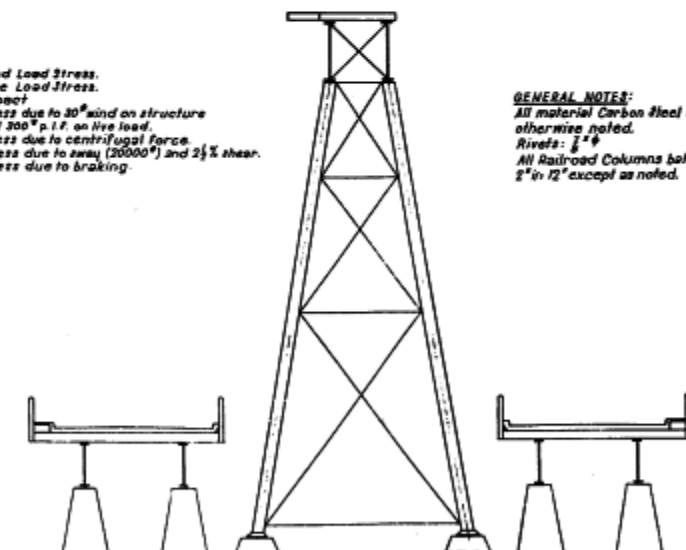

Assistant Bridge Engr.

TOWER STRESS SHEET
MISSISSIPPI RIVER BRIDGE
 AT BATON ROUGE, LA.
LOUISIANA HIGHWAY COMMISSION
 BATON ROUGE, LA. JUN 1927

DATE	DESCRIPTION	BY

164

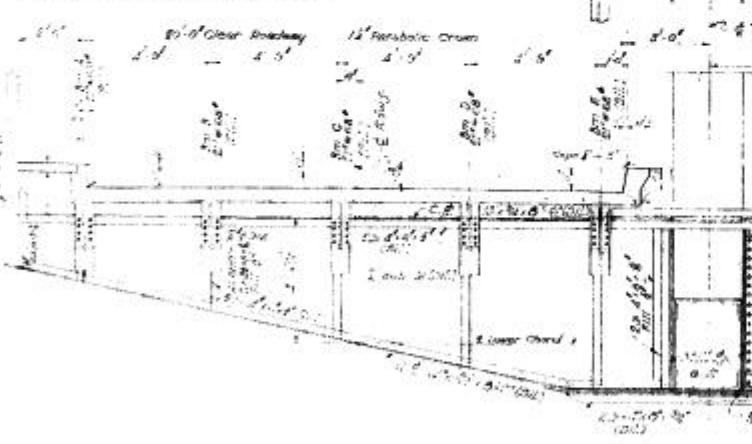
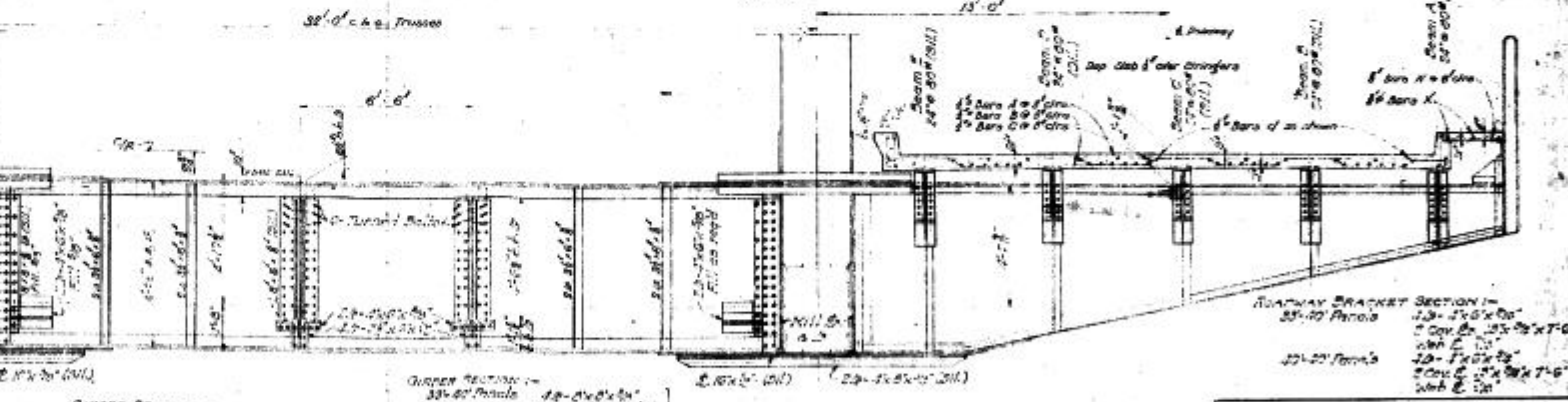
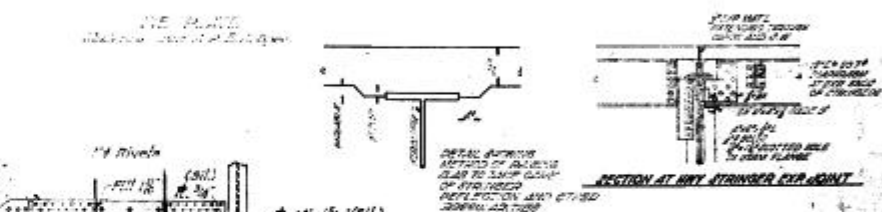
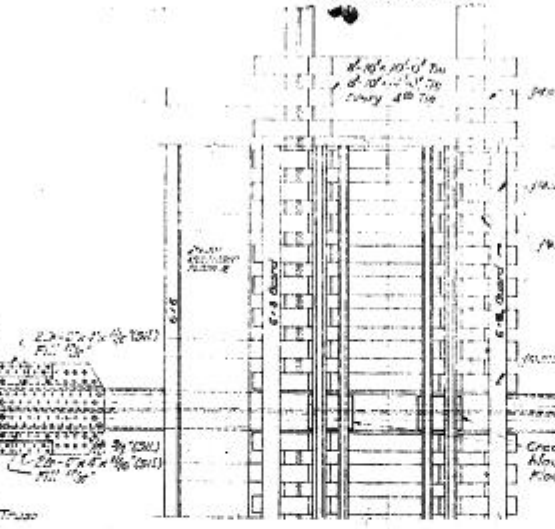
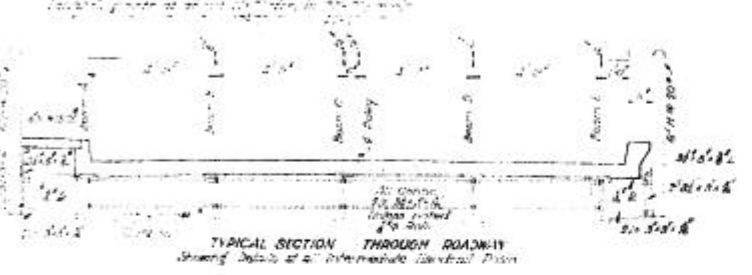
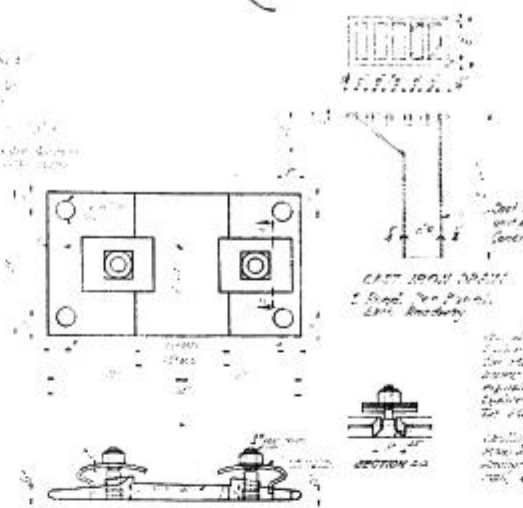
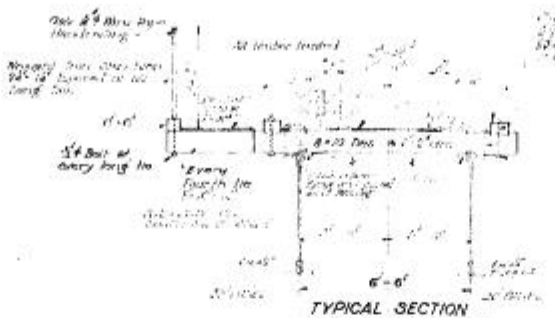
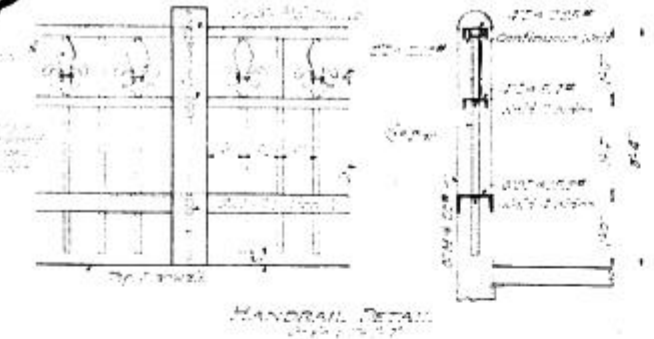

QUANTITIES PER LINEAR FOOT OF BRIDGE

2 1/2" DIA. WELD RODS	1.00
2 1/2" DIA. WELD RODS	1.00
2 1/2" DIA. WELD RODS	1.00
2 1/2" DIA. WELD RODS	1.00

TYPICAL CROSS SECTION OF ROADWAY

33'-0" Panels	2 1/2" DIA. WELD RODS	1.00
33'-0" Panels	2 1/2" DIA. WELD RODS	1.00
33'-0" Panels	2 1/2" DIA. WELD RODS	1.00
33'-0" Panels	2 1/2" DIA. WELD RODS	1.00

All detail material shall be carbon steel except as noted. Rivets in Roadway Floor System and Brackets shall be 7/8"; in Truss Connections and Floorbeams, 1".

ASSISTANT BRIDGE ENGR.

LOUISIANA HIGHWAY COMMISSION
 BATON ROUGE, LA.

AS BUILT PLANS



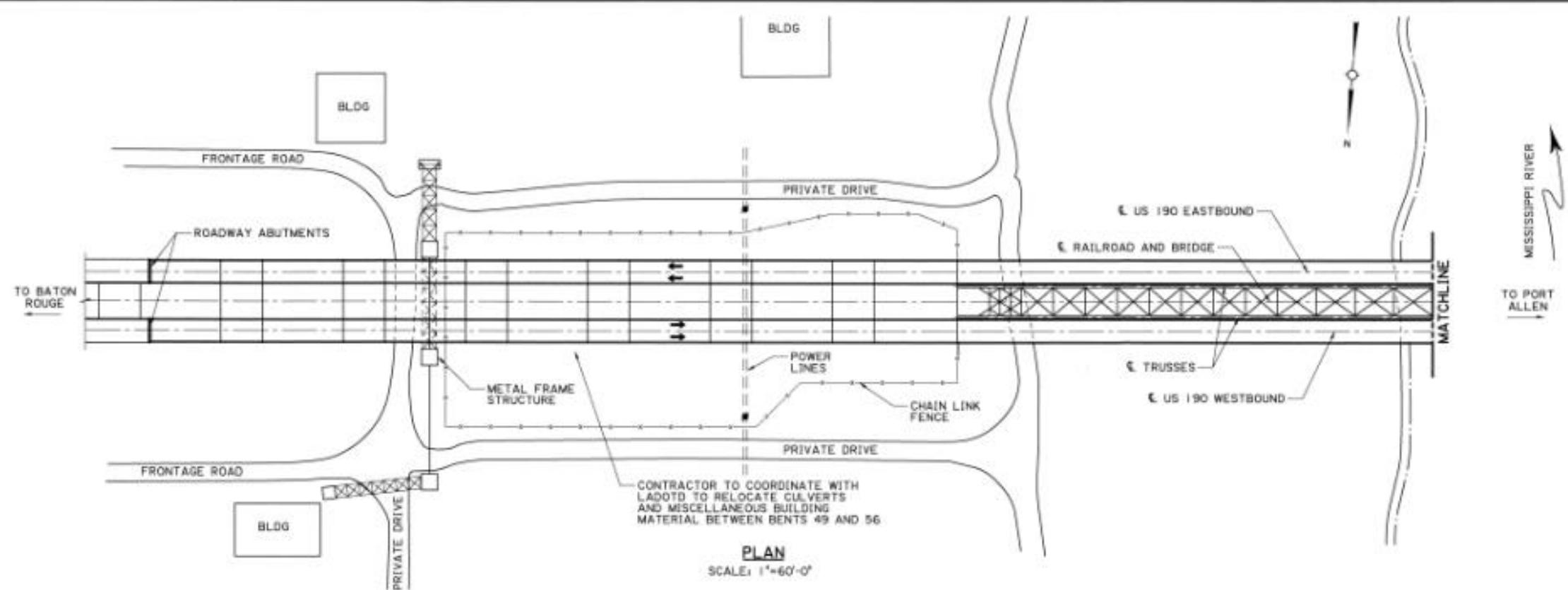

PLAN
SCALE: 1"=60'-0"

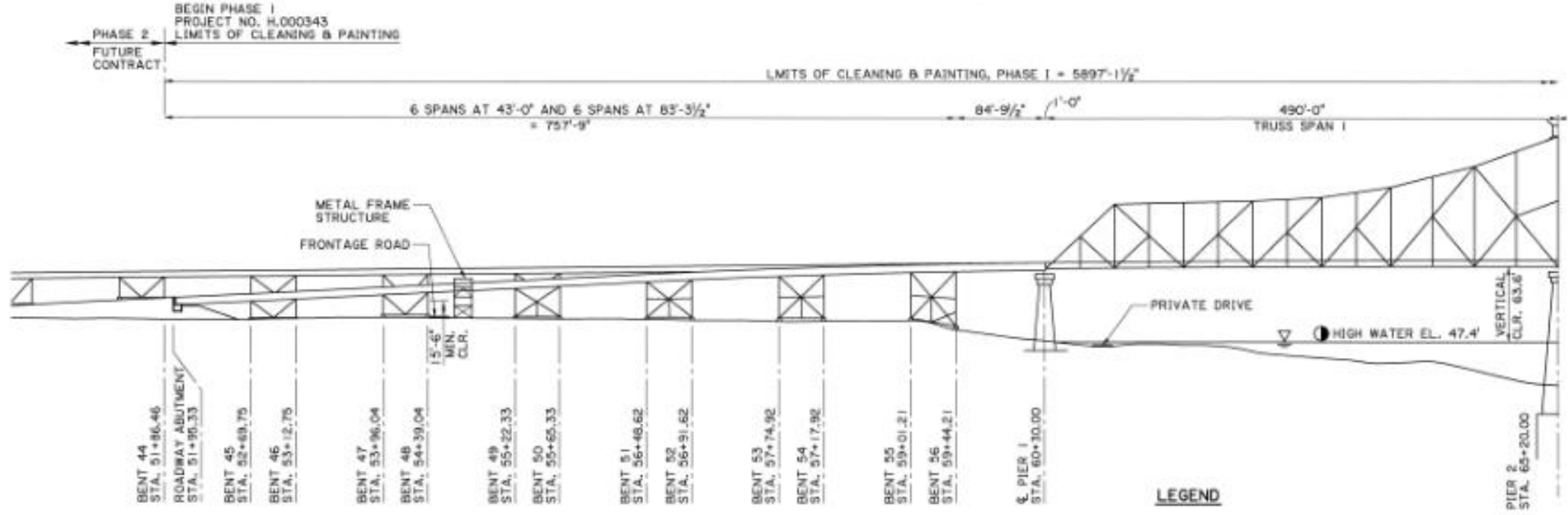

BRIDGE DIMENSIONS AND STATIONS SHOWN ARE BASED ON EXISTING PLANS. RIVER VERTICAL CLEARANCES AND CHANNEL DIMENSIONS ARE BASED ON U.S. COAST GUARD VESSEL TRAFFIC SERVICE LOWER MISSISSIPPI RIVER MANUAL.

ELEVATION
SCALE: 1"=60'-0"

- LEGEND**
- AVIATION LIGHTS TO BE MAINTAINED
 - NAVIGATION LIGHTS TO BE MAINTAINED
 - NAVIGATION LIGHTS TO BE MAINTAINED
 - THE WATER ELEVATIONS ARE TAKEN FROM AS-BUILT DRAWINGS

DESIGNED BY M. PAUL J. RICHARD	DATE 08/31/11	PROJECT NO. H.000343	SCALE 1 OF 4	PROJECT NAME EAST & WEST BATON ROUGE	PROJECT NO. H.000343	DATE 08/31/11	SCALE 1 OF 4
GENERAL PLAN AND ELEVATION US 190 OVER THE MISSISSIPPI RIVER							

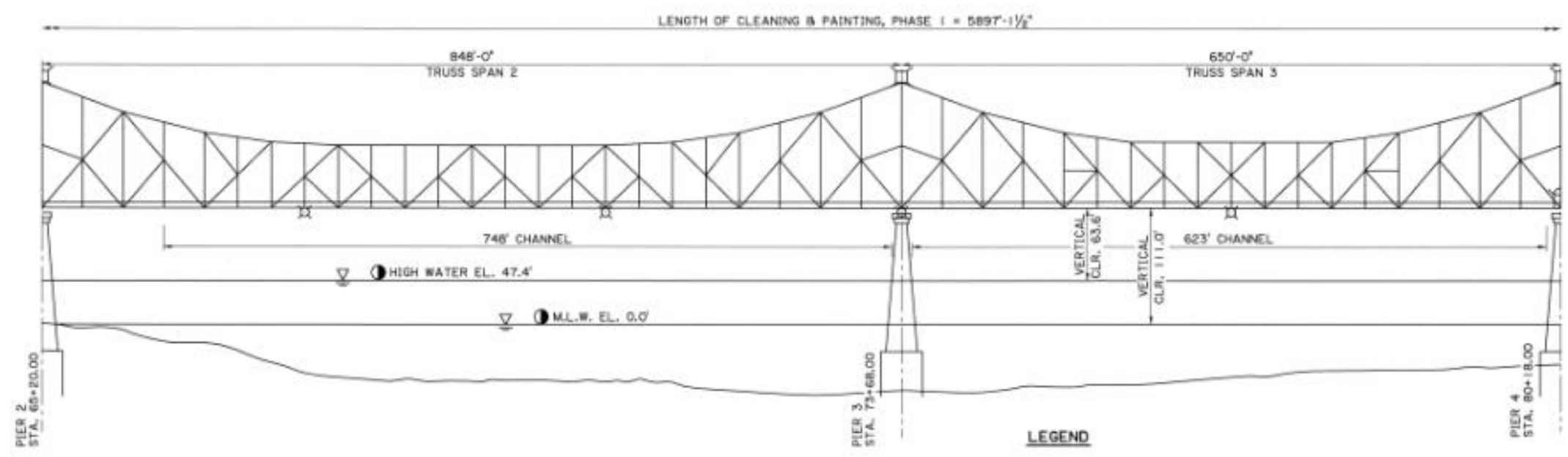
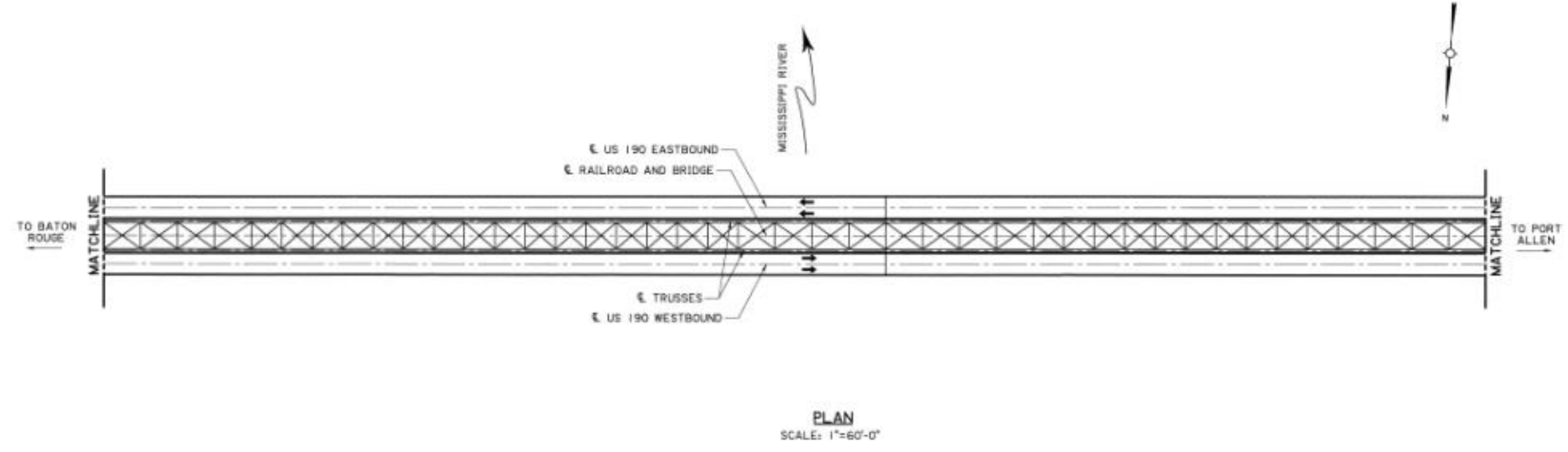

BRIDGE DIMENSIONS AND STATIONS SHOWN ARE BASED ON EXISTING PLANS. RIVER VERTICAL CLEARANCES AND CHANNEL DIMENSIONS ARE BASED ON U.S. COAST GUARD VESSEL TRAFFIC SERVICE LOWER MISSISSIPPI RIVER MANUAL.

- LEGEND**
- AVIATION LIGHTS TO BE MAINTAINED
 - NAVIGATION LIGHTS TO BE MAINTAINED
 - NAVIGATION LIGHTS TO BE MAINTAINED
 - THE WATER ELEVATIONS ARE TAKEN FROM AS-BUILT DRAWINGS



WEST NUMBER	114	EAST B. WEST BATON ROUGE	FL000343
DESIGNED BY	M-PALL	DATE	08/31/11
CHECKED BY	J. RICHARD	SCALE	2 OF 4
DATE	08/31/11	PROJECT	FL000343
REVISION DESCRIPTION			
NO.	DATE		
GENERAL PLAN AND ELEVATION			
US 190 OVER THE MISSISSIPPI RIVER			
CTRC			

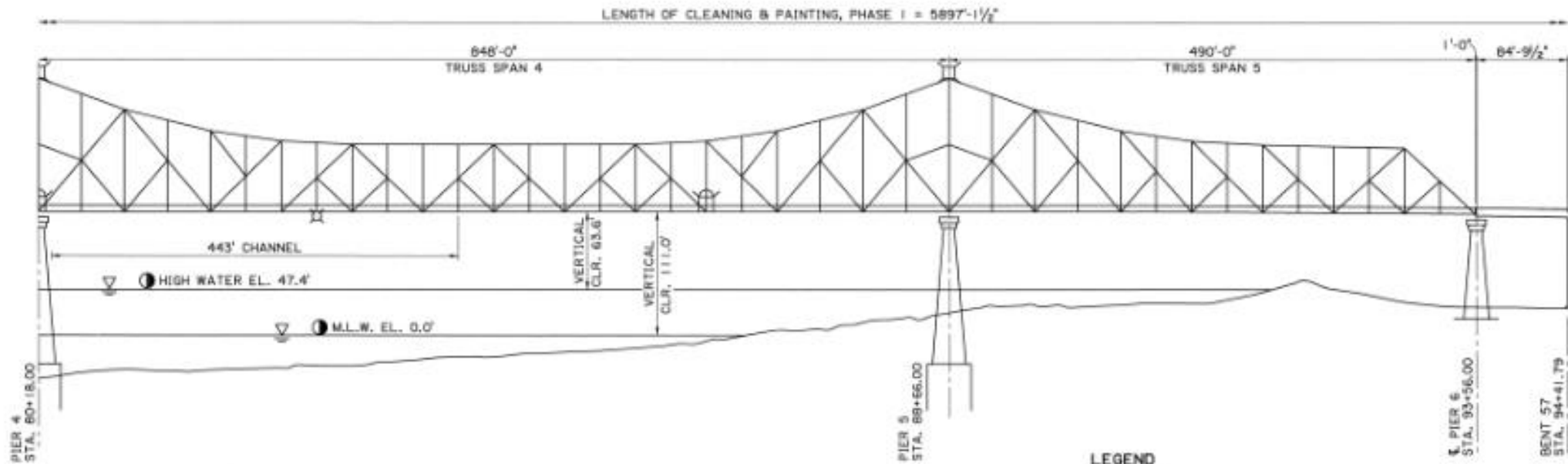
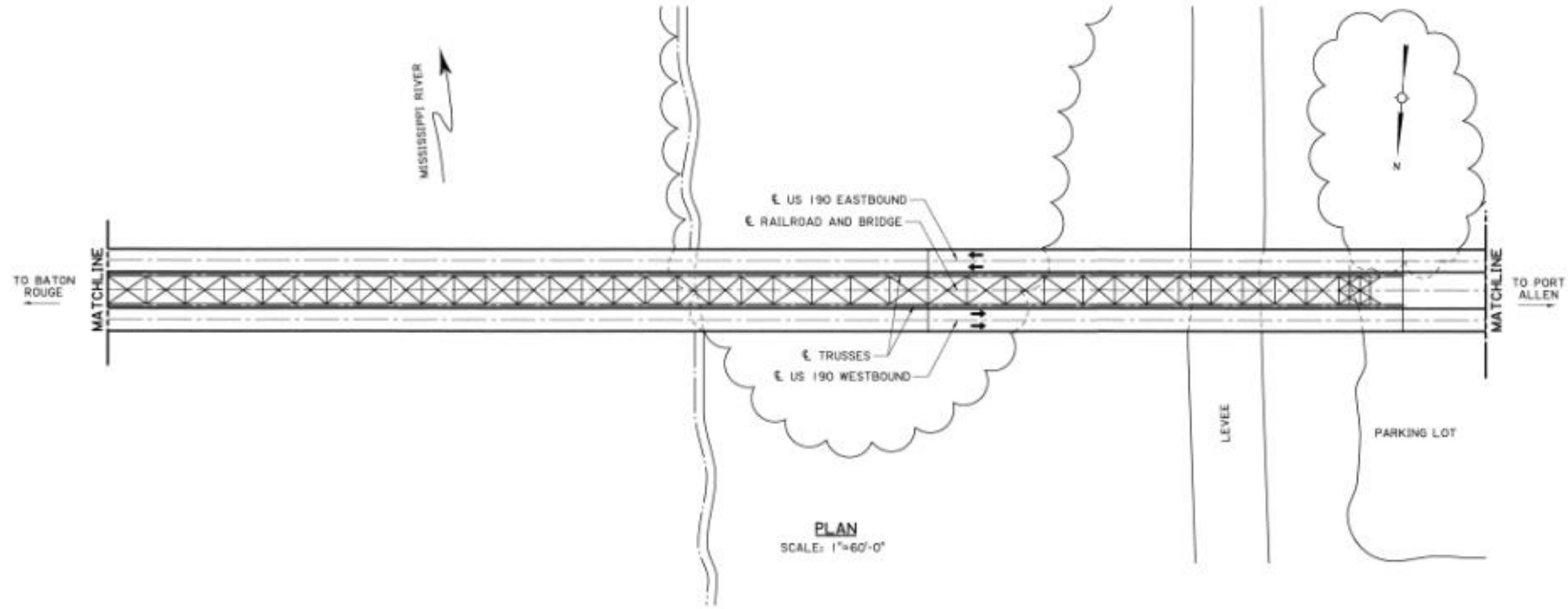

BRIDGE DIMENSIONS AND STATIONS SHOWN ARE BASED ON EXISTING PLANS. RIVER VERTICAL CLEARANCES AND CHANNEL DIMENSIONS ARE BASED ON U.S. COAST GUARD VESSEL TRAFFIC SERVICE LOWER MISSISSIPPI RIVER MANUAL.

LEGEND

- AVIATION LIGHTS TO BE MAINTAINED
- NAVIGATION LIGHTS TO BE MAINTAINED
- NAVIGATION LIGHTS TO BE MAINTAINED
- THE WATER ELEVATIONS ARE TAKEN FROM AS-BUILT DRAWINGS



GENERAL
PLAN AND ELEVATION

US 190 OVER THE MISSISSIPPI RIVER

DESIGNED BY	DATE	PROJECT	SCALE	SHEET NO.	TOTAL SHEETS
MP/ALL	08/11/11	US 190 OVER THE MISSISSIPPI RIVER	3 OF 4	37	41
DRAWN BY	DATE	PROJECT	SCALE	SHEET NO.	TOTAL SHEETS
JRICHARD	08/11/11	US 190 OVER THE MISSISSIPPI RIVER	3 OF 4	37	41
DATE	PROJECT	SCALE	SHEET NO.	TOTAL SHEETS	
08/11/11	US 190 OVER THE MISSISSIPPI RIVER	3 OF 4	37	41	

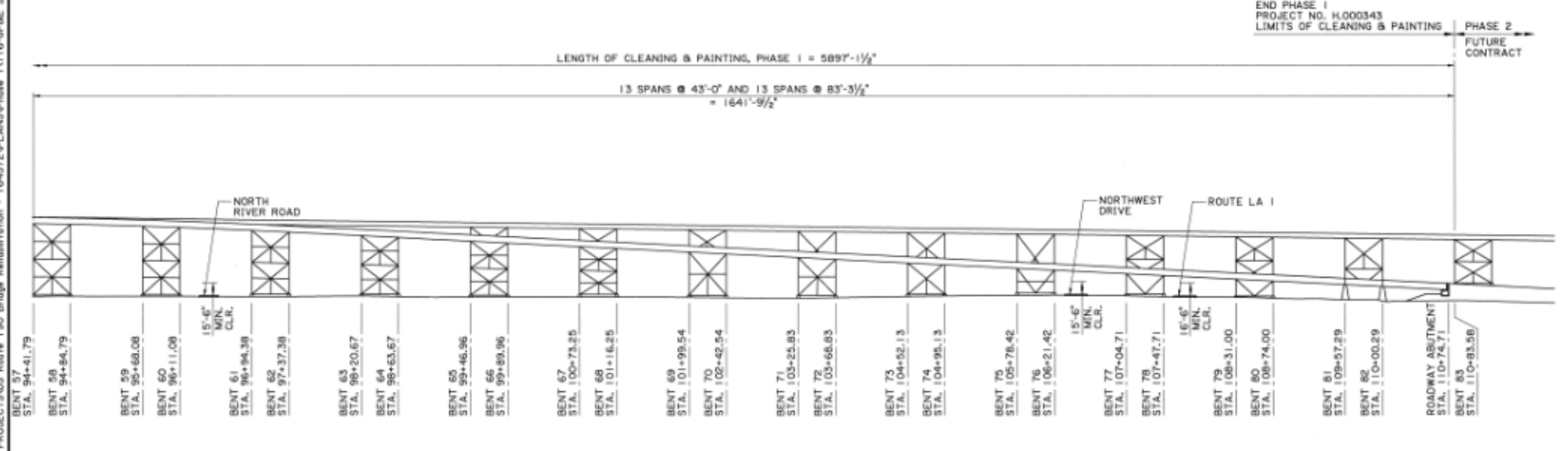
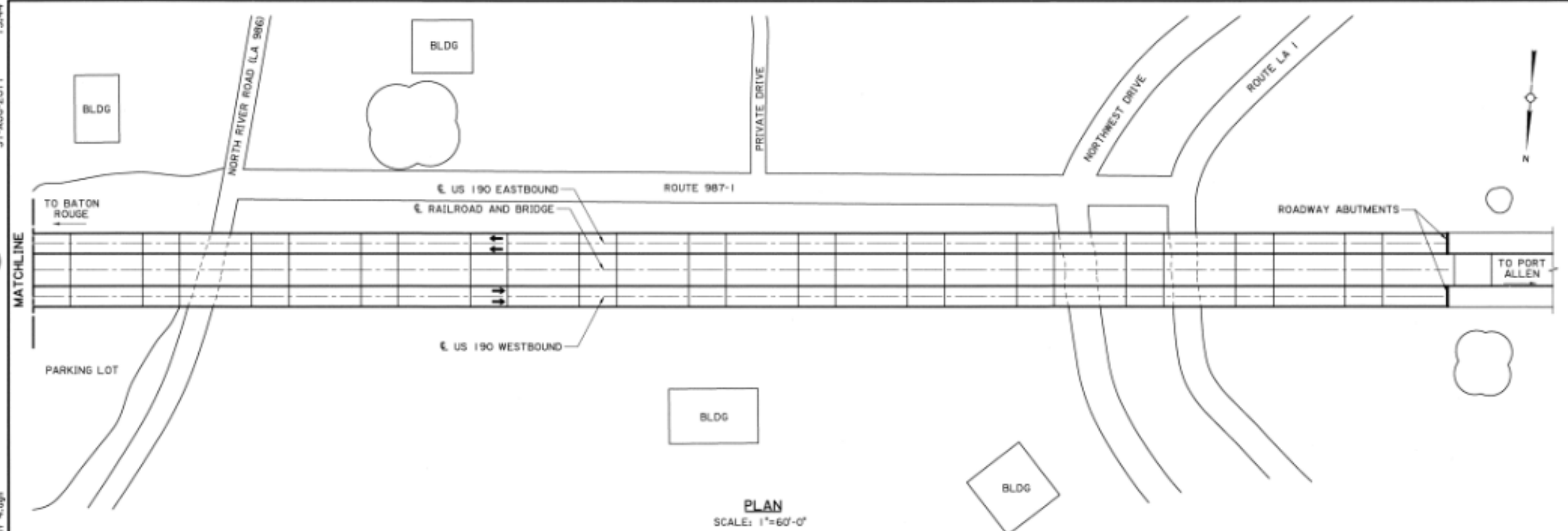

BRIDGE DIMENSIONS AND STATIONS SHOWN ARE BASED ON EXISTING PLANS.



DESIGNED BY MICHAEL J. RICHARD	DATE 08/25/11	PROJECT NO. H.000343
DRAWN BY T. PILES	DATE 08/25/11	PROJECT NO. H.000343
CHECKED BY MICHAEL J. RICHARD	DATE 08/25/11	PROJECT NO. H.000343
SCALE 4 OF 4	DATE 08/25/11	PROJECT NO. H.000343
EAST & WEST BATON ROUGE US 190 OVER THE MISSISSIPPI RIVER GENERAL PLAN AND ELEVATION		

ENVIRONMENTAL SAMPLING, TESTING AND MONITORING:

VISIBLE EMISSION ASSESSMENT: THE CONTRACTOR SHALL PROHIBIT ALL CUMULATIVE VISIBLE EMISSIONS GREATER IN DURATION THAN 1 PERCENT OF THE WORK DAY WHEN MEASURED IN ACCORDANCE WITH EPA METHOD 22. VISUAL ASSESSMENT SHALL BE CONDUCTED BY AN INDEPENDENT THIRD PARTY ENVIRONMENTAL TESTING FIRM UNDER SEPARATE CONTRACT WITH THE OWNER.

TSP MONITORING FOR LEAD: THE CONTRACTOR SHALL CONDUCT HIS PAINT REMOVAL AND CLEANING OPERATIONS SUCH THAT EMISSIONS OF LEAD SHALL NOT BE IN EXCESS OF 1.5 µG/M³ OVER A 24-HOUR PERIOD. MONITORING FOR THIS LEVEL SHALL BE ACCOMPLISHED USING HIGH VOLUME TSP (TOTAL SUSPENDED PARTICULATE) AIR SAMPLERS IN ACCORDANCE WITH 40 CFR 50.

EMISSIONS IN EXCESS OF 1.5 µG/M³ IN ANY 24-HOUR PERIOD SHALL BE CAUSE FOR SHUT DOWN OF THE PROJECT UNTIL CORRECTIONS ARE MADE TO THE CONTAINMENT OR WORK PROCEDURES ARE MODIFIED TO COMPLY WITH THIS LEVEL OF EMISSIONS.

SEVEN (7) DAYS OF BASELINE MONITORING PRIOR TO PROJECT START-UP WILL BE UNDERTAKEN TO DETERMINE PRE-EXISTING CONDITIONS.

SOIL SAMPLING: INSPECT THE GROUND BENEATH AND IN PROXIMITY TO THE STRUCTURE IN THE PRESENCE OF THE ENGINEER FOR VISIBLE PAINT CHIPS TO ESTABLISH AN INITIAL JOB SITE CLEANLINESS STANDARD. TEST SOIL SAMPLES PRIOR TO THE BEGINNING OF OPERATIONS AND AFTER PROJECT COMPLETION FOR HEAVY METALS. DOCUMENT THE NUMBER AND SPECIFIC LOCATIONS WHERE THE INITIAL SAMPLES ARE TAKEN AS OUTLINED IN THE SSPC PROJECT DESIGN-INDUSTRIAL LEAD PAINT REMOVAL HANDBOOK, VOLUME 2 TO ENSURE THE POST SAMPLES ARE COLLECTED FROM THE SAME LOCATIONS. SUBMIT ALL SAMPLES TO THE ENGINEER FOR REVIEW IN ADDITION, SUBMIT A PRE- AND POST-SOIL SAMPLING PLAN FOR STORAGE AREAS IDENTIFYING THE SAMPLE, LOCATION, DEPTH, ANALYSES LIST, LAB CERTIFICATION, AND TURNAROUND TIME. ONCE APPROVED BY THE ENGINEER, SUBMIT SAMPLING RESULTS ALONG WITH A SCALED DRAWING INDICATING DESIGNATED SAMPLE LOCATIONS.

WASTE DISPOSAL:

DISPOSAL REQUIREMENTS DESCRIBED BELOW ARE REFERENCED TO THE SSPC-GUIDE 7 (DIS). DEBRIS GENERATED BY THE CONTRACTOR'S CLEANING OPERATION, INCLUDING WASTE WATER, ABRASIVE BLAST RESIDUE, SPENT BLAST MEDIUMS, RUST, MILL SCALE, PAINT PARTICLES AND DUST SHALL BE REMOVED FROM THE CONTAMINANT AREA AT LEAST ONCE PER DAY. THESE WASTES SHALL BE COLLECTED IN LEAK-PROOF CONTAINERS WHICH SHALL BE CLEARLY MARKED OF THE HAZARDS OF ITS CONTENTS, TARE WEIGHT OF THE CONTAINER, AND ORIGIN AND DATE OF THE MATERIAL COLLECTION WITH WEATHER RESISTANT LABELS. TRANSFER OF THIS MATERIAL FROM THE WORK AREA TO THE CONTAINERS AND THE STORAGE SITE FOR THE CONTAINERS SHALL BE SUCH THAT NO POLLUTION OF THE ENVIRONMENT WILL OCCUR AND WORKERS ARE FULLY PROTECTED. THE CONTAINERS SHALL BE TRANSPORTED TO A TEMPORARY STORAGE SITE IN ACCORDANCE WITH 40 CFR PART 263; "LAC 33:V." THE CONTRACTOR WILL BE RESPONSIBLE FOR OBTAINING THE TEMPORARY STORAGE SITE AT NO ADDITIONAL CHARGE TO THE DEPARTMENT. THIS SITE SHALL BE SECURE, PROVIDING PROTECTION FROM MIGRATION OF THE WASTE INTO THE ENVIRONMENT AND FROM VANDALISM AND PUBLIC ACCESS. WARNING SIGNS SHALL BE PROMINENTLY DISPLAYED AROUND THE PERIMETER OF THE SITE. THE WASTES MAY REMAIN AT THE TEMPORARY STORAGE SITE NO LONGER THAN NINETY (90) CALENDAR DAYS.

ALL WASTE STREAMS SHALL BE STORED IN SEPARATE CONTAINERS. THESE WASTE STREAMS SHALL BE SAMPLED AND TESTED IN ACCORDANCE WITH EPA METHOD 1311, "TOXICITY CHARACTERISTICS LEACHING PROCEDURE" (TCLP), TO DETERMINE THEIR CLASSIFICATION AND SHALL BE PROPERLY DISPOSED OF BASED ON THAT CLASSIFICATION.

ALL WASTE REGARDLESS OF REMOVAL METHOD SHALL BE PRESUMED TO BE HAZARDOUS UNTIL IT IS CLEARLY DEMONSTRATED BY APPROPRIATE SAMPLING AND TESTING TO BE NON-HAZARDOUS.

WASTES FOUND TO BE HAZARDOUS ARE SUBJECT TO THE PROVISIONS OF THE RCRA. TRANSPORTATION OF HAZARDOUS WASTES FOR TREATMENT AND DISPOSAL SHALL BE COMPLETELY MANIFESTED IN ACCORDANCE WITH 40 CFR PART 262; "LAC 33:V." A MANIFEST WILL BE REQUIRED FOR TRANSPORT OF BOTH HAZARDOUS AND NON-HAZARDOUS WASTE. THE MANIFEST SHALL BE RETURNED TO THE ENGINEER.

WASTES FOUND BY TESTING TO BE NON-HAZARDOUS MAY BE DISPOSED OF IN A SUBTITLE D (NON-HAZARDOUS) LANDFILL. SEE LAC 33:VII "SOLID WASTE REGULATIONS".

SPECIAL STENCILING:

THE DATE (MONTH AND YEAR) OF PAINTING AND TYPE OF PAINT SYSTEM USED SHALL BE STENCILED AT TWO (2) LOCATIONS DETERMINED BY THE ENGINEER ON ALL STRUCTURES IN BLOCK LETTERS 2-1/2 INCHES (63 MM) HIGH. THE PAINT USED SHALL FORM A CONTRAST WITH THE BACKGROUND AND SHALL BE COMPATIBLE WITH THE PAINT SYSTEM USED.

LACING BAR REMOVAL FOR ACCESS: REMOVAL AND RE-INSTALLATION OF LACING BARS, STAY PLATES AND OTHER STRUCTURAL ITEMS (AND REMOVAL AND REPLACEMENT OF ASSOCIATED RIVETS WITH HIGH-STRENGTH BOLTS) FOR CLEANING AND PAINTING PURPOSES AND ACCESS ARE INCLUDED UNDER AND SHALL BE PAID AS PART OF PAY ITEM NS-800-00020, CLEANING, PAINTING, AND DISPOSAL (NEAR WHITE FINISH). ALL MEMBERS (TENSION AND COMPRESSION) SHALL HAVE TEMPORARY BRACING WHEN MORE THAN ONE SECTION OF LACING IS REMOVED. TEMPORARY BRACING METHODS FOR LACING REMOVAL SHALL BE ANALYZED AND SEALED BY A PROFESSIONAL ENGINEER LICENSED TO PRACTICE IN THE STATE OF LOUISIANA AND SUBMITTED TO THE PROJECT ENGINEER FOR APPROVAL.

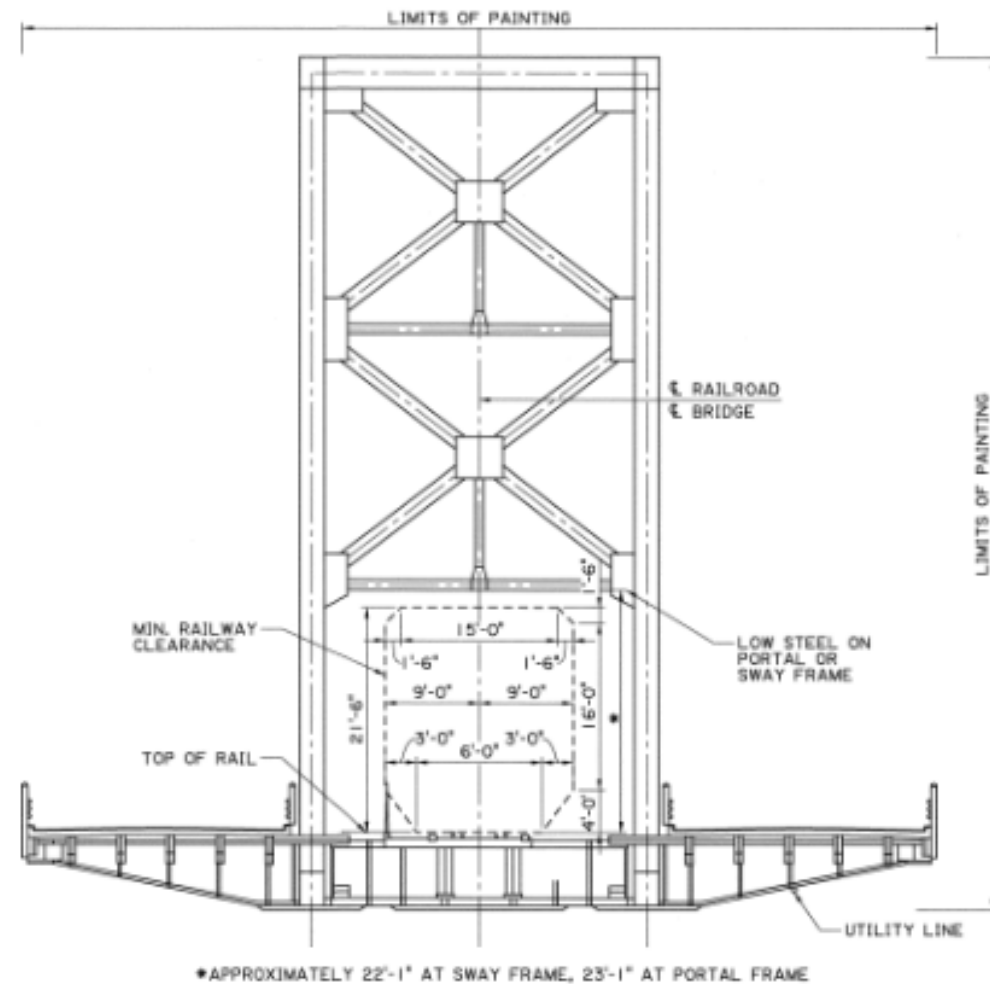

*APPROXIMATELY 22'-1" AT SWAY FRAME, 23'-1" AT PORTAL FRAME

TRUSS SPAN TYPICAL CROSS SECTION
(N.T.S.)

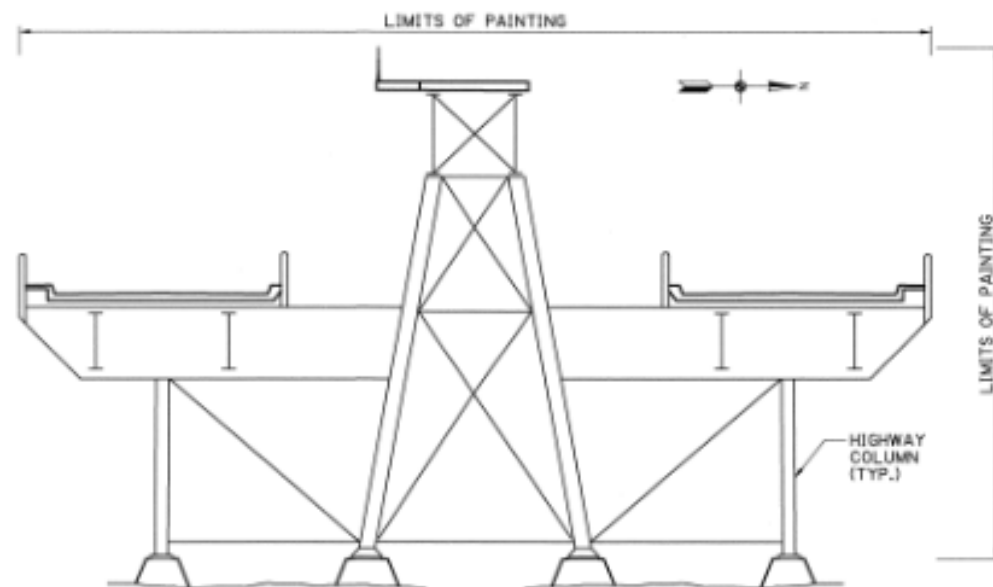

APPROACH SPAN TYPICAL CROSS SECTION
(N.T.S.)

SHEET NUMBER	104
PROJECT	EAST & WEST BATON ROUGE
DESIGNED BY	DARRIN J. ARNONE
CHECKED BY	WILLIAM C. BAILEY
DATE	08/23/11
SHEET	4 OF 12
PROJECT	H-000343
REVISION DESCRIPTION	
DATE	
SCALE	
 GENERAL NOTES US 190 OVER THE MISSISSIPPI RIVER	
 CTRC	

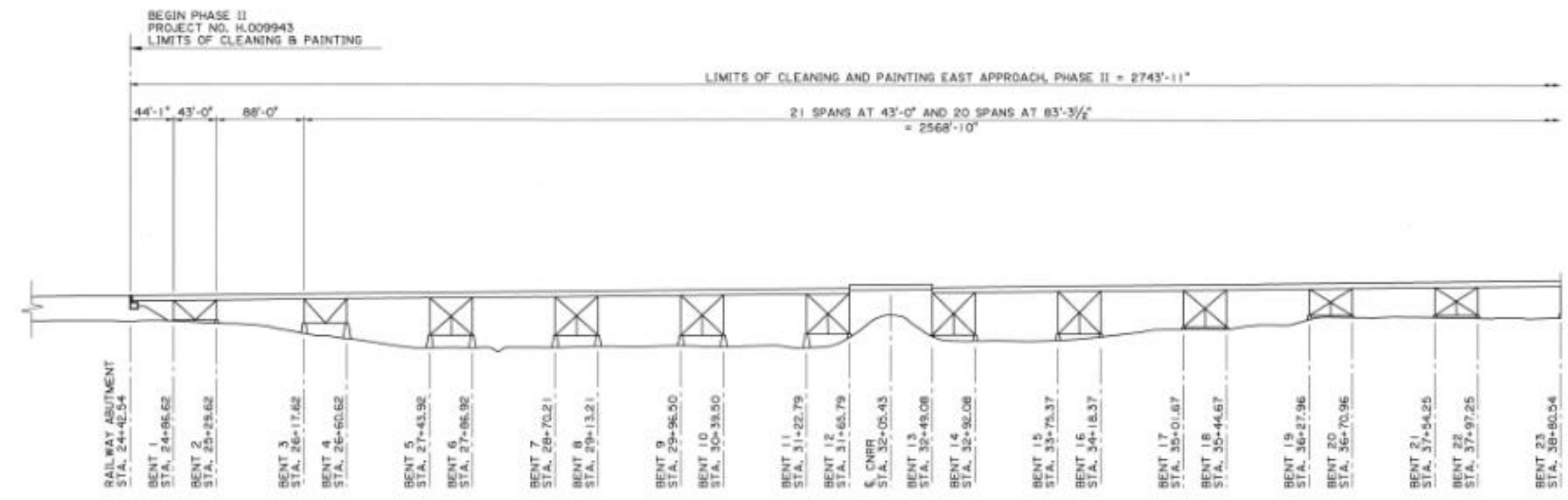
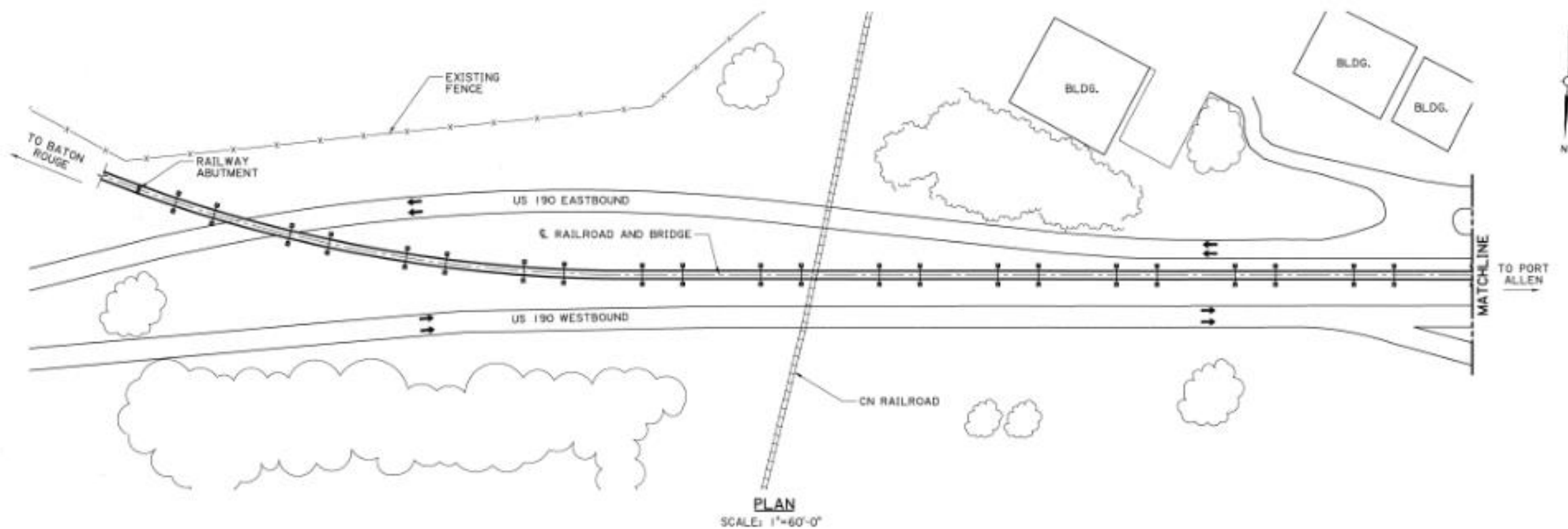

ELEVATION
SCALE: 1"=60'-0"

BRIDGE DIMENSIONS AND STATIONS SHOWN ARE BASED ON EXISTING PLANS.



DESIGNED BY: M. J. PAUL	PROJECT: EAST & WEST BATON ROUGE
DRAWN BY: J. RICHARD	PROJECT: H.009943
CHECKED BY: J. RICHARD	DATE: 10/26/12
CHECKED BY: M. J. PAUL	SHEET: 1 OF 5

STATE OF LOUISIANA
Professional Engineer
JOHN D. FINKBEINER
10764
10/26/12

GENERAL PLAN AND ELEVATION
US 190 OVER THE MISSISSIPPI RIVER (PHASE II)

CTRC

FINAL PLANS

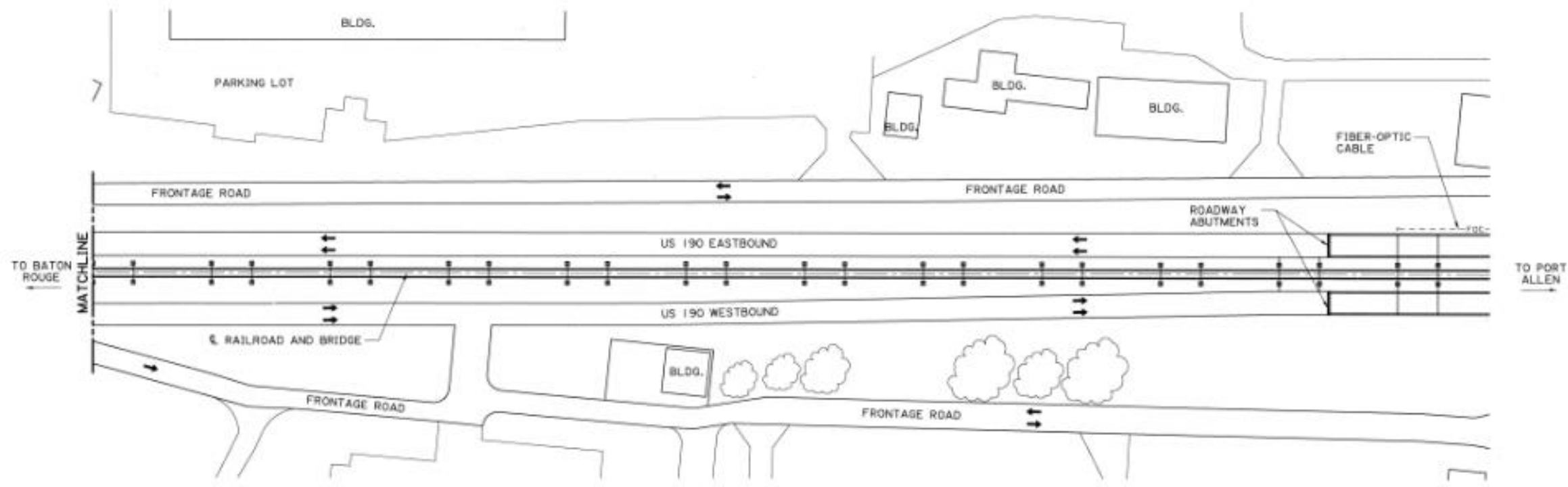

PLAN
SCALE: 1"=60'-0"

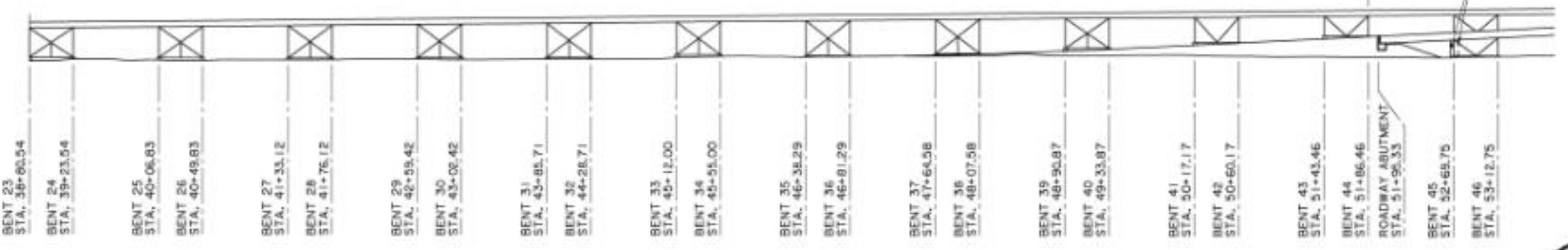
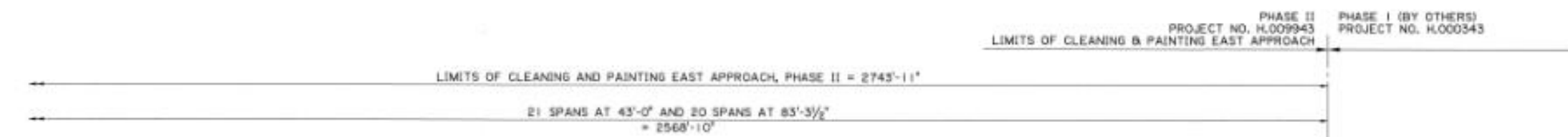

ELEVATION
SCALE: 1"=60'-0"

BRIDGE DIMENSIONS AND STATIONS SHOWN ARE BASED ON EXISTING PLANS.



PROJECT NO.	H.009943
PROJECT NAME	EAST & WEST BATON ROUGE
DATE	10/25/12
SCALE	2 OF 5
DESIGNER	M.P.A.L.
CHECKER	L.J.C.H.A.R.D.
APPROVER	M.P.A.L.
DATE	10/25/12
SCALE	2 OF 5

STATE OF LOUISIANA
PROFESSIONAL ENGINEER
JOHN D. SCHIRO
LICENSE NO. 2188
10/25/12

GENERAL PLAN AND ELEVATION
US 190 OVER THE MISSISSIPPI RIVER (PHASE II)

CTRC



FINAL PLANS

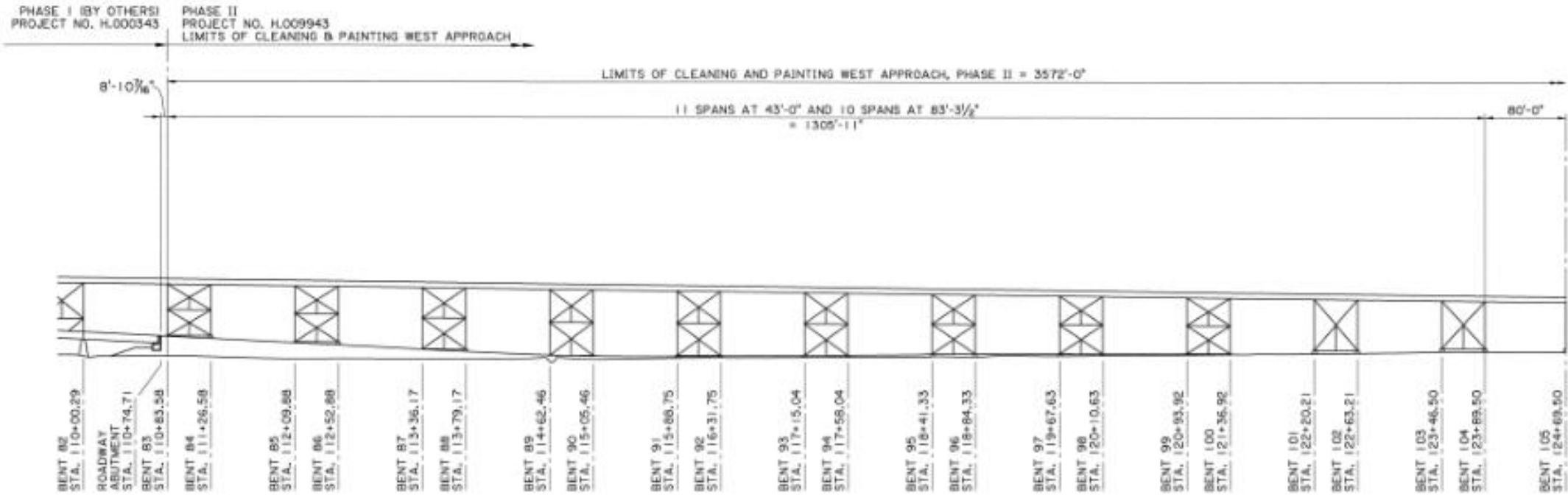
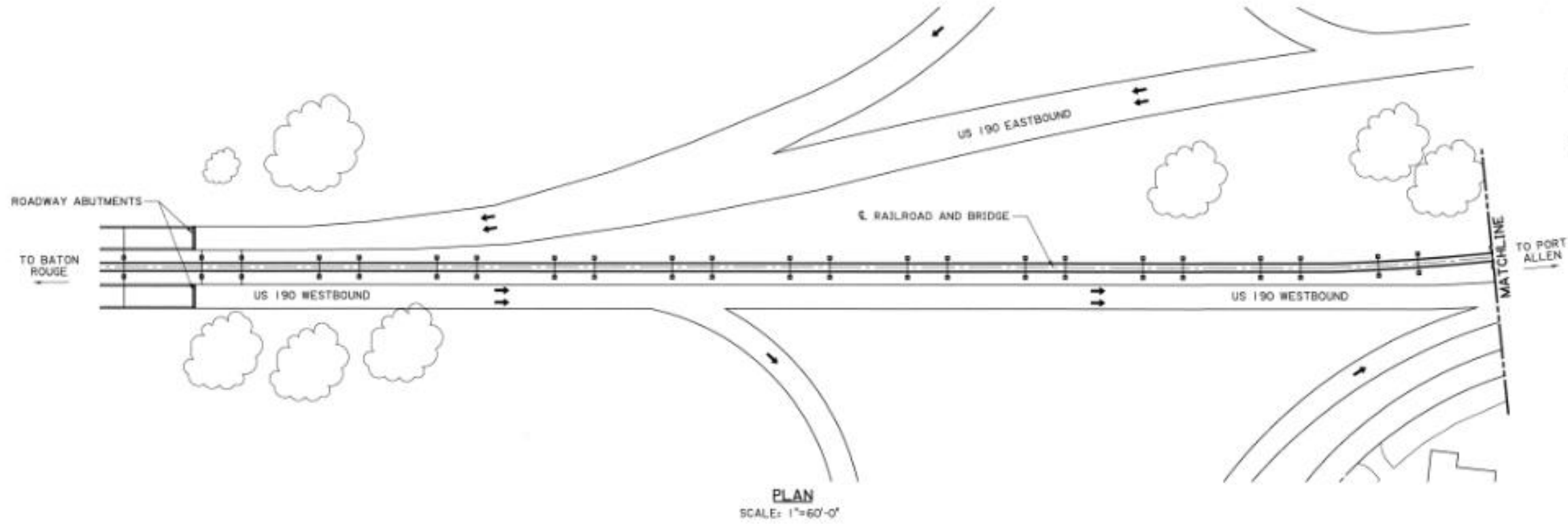

ELEVATION SCALE: 1"=60'-0"

BRIDGE DIMENSIONS AND STATIONS SHOWN ARE BASED ON EXISTING PLANS.



SHEET NUMBER 113	
PROJECT: M. PAUL J. RICHARD	FACILITY: EAST & WEST BATON ROUGE
DESIGNED BY: J. J. JONES	FEDERAL PROJECT:
CHECKED BY: M. PAUL	STATE PROJECT:
DATE: 10/26/12	STATE: LA
SHEET: 5 OF 5	PROJECT NO.: H.009943

GENERAL PLAN AND ELEVATION

US 190 OVER THE MISSISSIPPI RIVER (PHASE II)

CTRC



FINAL PLANS

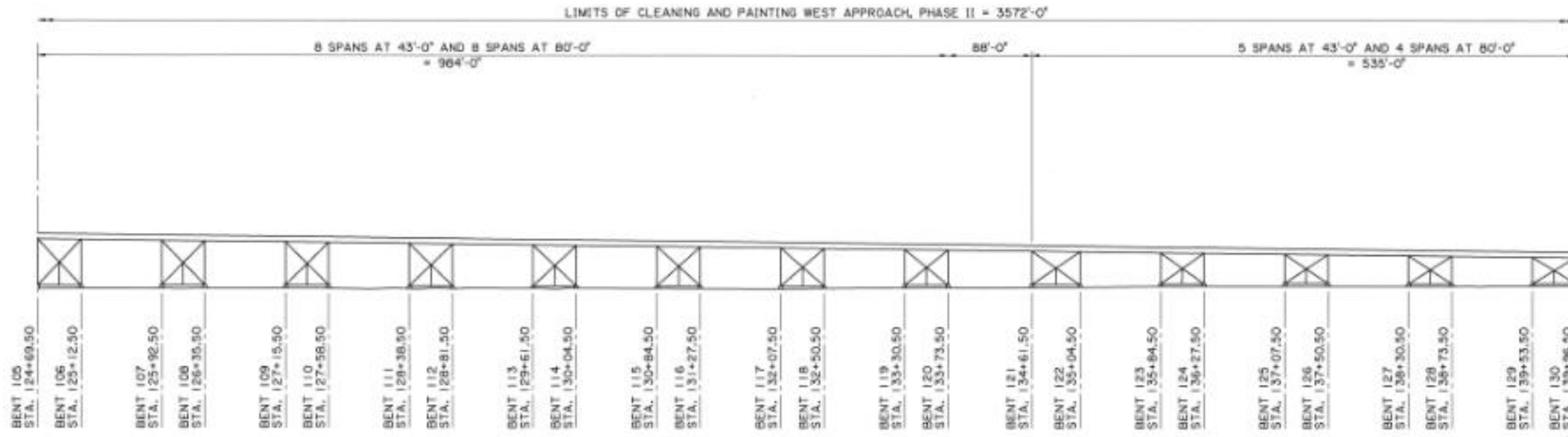
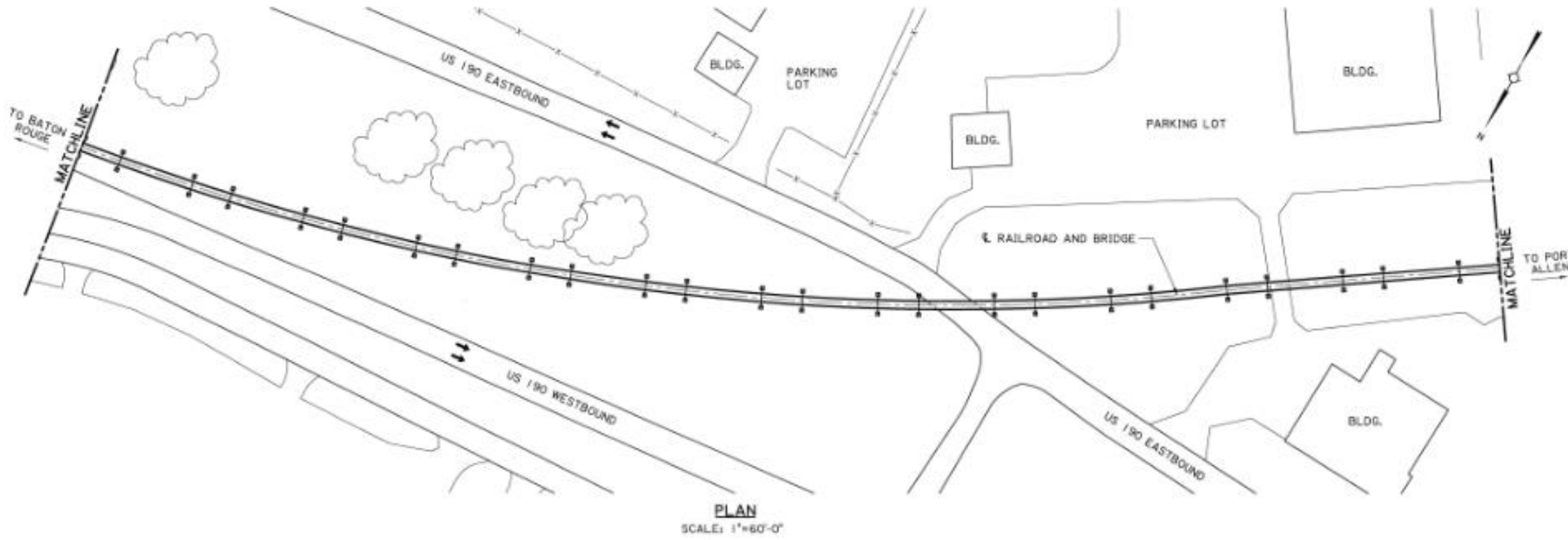

ELEVATION
SCALE: 1"=60'-0"

BRIDGE DIMENSIONS AND STATIONS SHOWN ARE BASED ON EXISTING PLANS.



PROJECT	EAST B WEST BATON ROUGE	SHEET	114
DESIGNED BY	M.P.ALL	DATE	10/25/12
CHECKED BY	J. J. JONES	SCALE	4 OF 5
PROJECT NO.	N.009943		

GENERAL PLAN AND ELEVATION

US 190 OVER THE MISSISSIPPI RIVER (PHASE II)

CTRC

FINAL PLANS

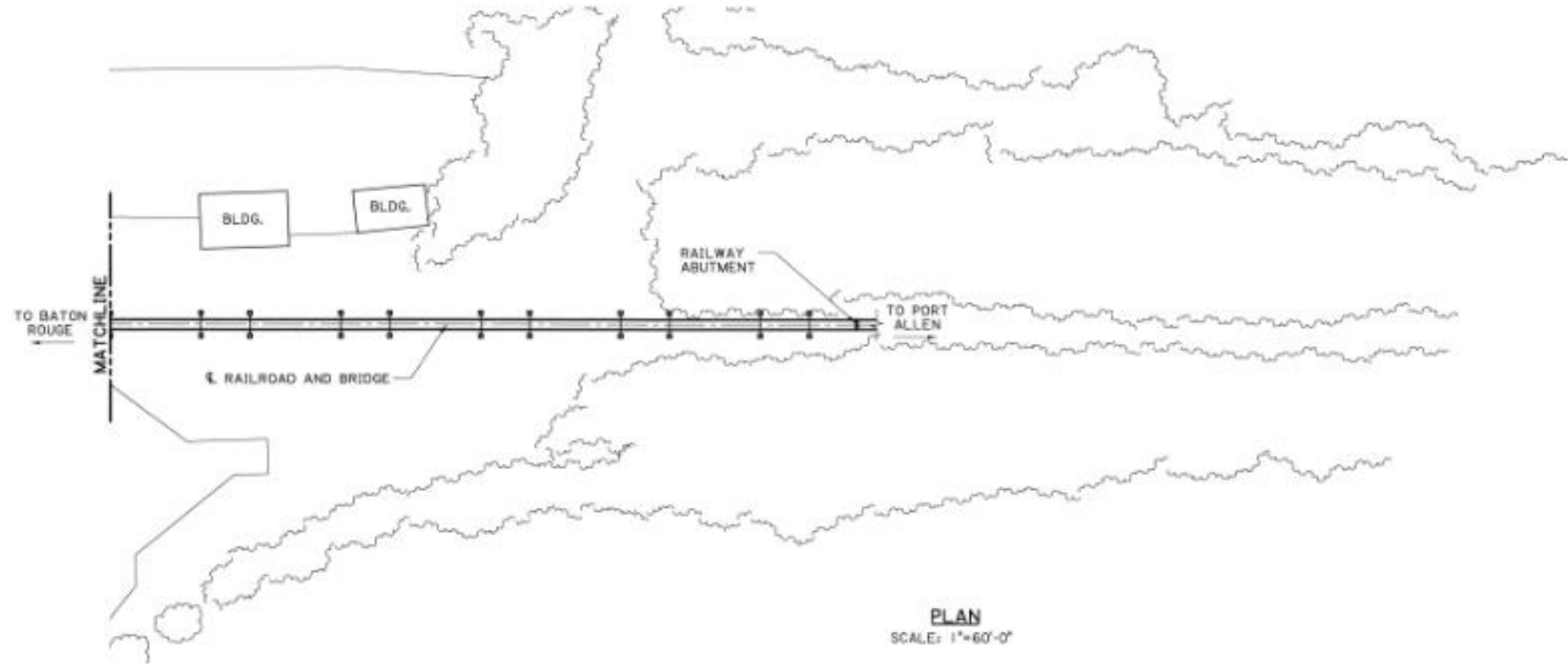

PLAN
SCALE: 1"=60'-0"

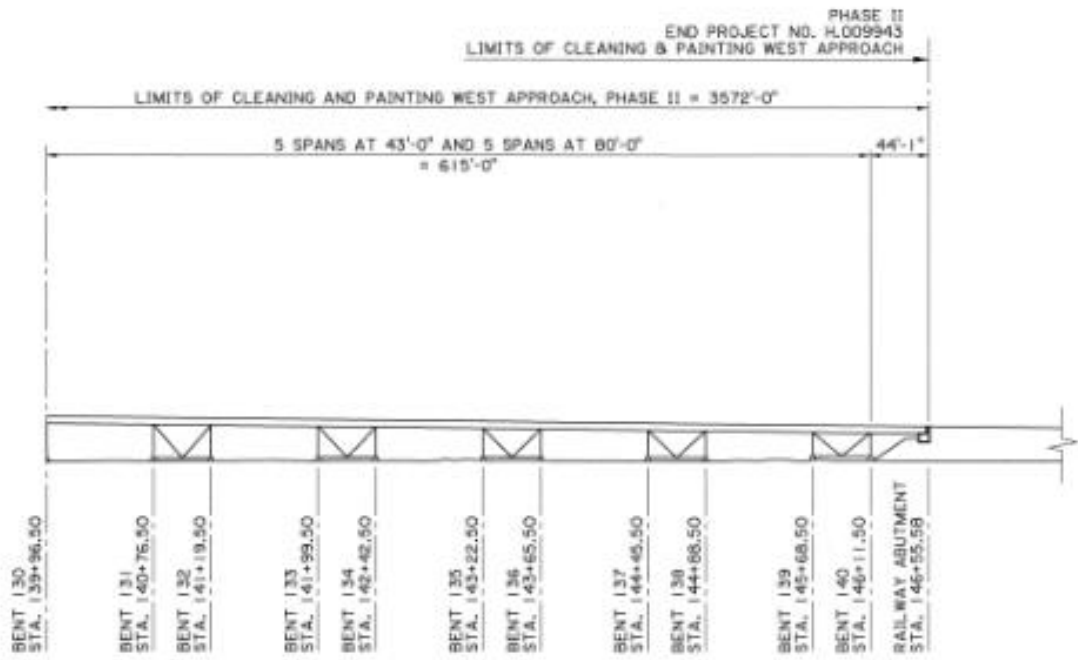

ELEVATION
SCALE: 1"=60'-0"

BRIDGE DIMENSIONS AND STATIONS SHOWN ARE BASED ON EXISTING PLANS.



		GENERAL PLAN AND ELEVATION		US 190 OVER THE MISSISSIPPI RIVER (PHASE 2)	
		EAST & WEST BATON ROUGE		115	
M. PAUL DESIGNER	J. RICHARDSON DESIGNER	M. PAUL PROJECT	J. RICHARDSON PROJECT	H.009943	5 OF 5
DATE: 10/26/12	WEST:	EAST:	SECTION DESCRIPTION:	SHEET:	TOTAL SHEETS:

ENVIRONMENTAL SAMPLING, TESTING AND MONITORING:

VISIBLE EMISSION ASSESSMENT: THE CONTRACTOR SHALL PROHIBIT ALL CUMULATIVE VISIBLE EMISSIONS GREATER IN DURATION THAN 1 PERCENT OF THE WORK DAY WHEN MEASURED IN ACCORDANCE WITH EPA METHOD 22. VISUAL ASSESSMENT SHALL BE CONDUCTED BY AN INDEPENDENT THIRD PARTY ENVIRONMENTAL TESTING FIRM UNDER SEPARATE CONTRACT WITH THE OWNER.

TSP MONITORING FOR LEAD: THE CONTRACTOR SHALL CONDUCT HIS PAINT REMOVAL AND CLEANING OPERATIONS SUCH THAT EMISSIONS OF LEAD SHALL NOT BE IN EXCESS OF 1.5 µG/M³ OVER A 24-HOUR PERIOD. MONITORING FOR THIS LEVEL SHALL BE ACCOMPLISHED USING HIGH VOLUME TSP (TOTAL SUSPENDED PARTICULATE) AIR SAMPLERS IN ACCORDANCE WITH 40 CFR 50.

EMISSIONS IN EXCESS OF 1.5 µG/M³ IN ANY 24-HOUR PERIOD SHALL BE CAUSE FOR SHUT DOWN OF THE PROJECT UNTIL CORRECTIONS ARE MADE TO THE CONTAINMENT OR WORK PROCEDURES ARE MODIFIED TO COMPLY WITH THIS LEVEL OF EMISSIONS.

SEVEN (7) DAYS OF BASELINE MONITORING PRIOR TO PROJECT START-UP WILL BE UNDERTAKEN TO DETERMINE PRE-EXISTING CONDITIONS.

SOIL SAMPLING: INSPECT THE GROUND BENEATH AND IN PROXIMITY TO THE STRUCTURE IN THE PRESENCE OF THE ENGINEER FOR VISIBLE PAINT CHIPS TO ESTABLISH AN INITIAL JOB SITE CLEANLINESS STANDARD. TEST SOIL SAMPLES PRIOR TO THE BEGINNING OF OPERATIONS AND AFTER PROJECT COMPLETION FOR HEAVY METALS. DOCUMENT THE NUMBER AND SPECIFIC LOCATIONS WHERE THE INITIAL SAMPLES ARE TAKEN AS OUTLINED IN THE SSPC PROJECT DESIGN-INDUSTRIAL LEAD PAINT REMOVAL HANDBOOK, VOLUME 2 TO ENSURE THE POST SAMPLES ARE COLLECTED FROM THE SAME LOCATIONS. SUBMIT ALL SAMPLES TO THE ENGINEER FOR REVIEW IN ADDITION, SUBMIT A PRE- AND POST-SOIL SAMPLING PLAN FOR STORAGE AREAS (IDENTIFYING THE SAMPLE, LOCATION, DEPTH, ANALYSES LIST, LAB CERTIFICATION, AND TURNAROUND TIME. ONCE APPROVED BY THE ENGINEER, SUBMIT SAMPLING RESULTS ALONG WITH A SCALED DRAWING INDICATING DESIGNATED SAMPLE LOCATIONS.

WASTE DISPOSAL:

DISPOSAL REQUIREMENTS DESCRIBED BELOW ARE REFERENCED TO THE SSPC-GUIDE 7 (DIS). DEBRIS GENERATED BY THE CONTRACTOR'S CLEANING OPERATION, INCLUDING WASTE WATER, ABRASIVE BLAST RESIDUE, SPENT BLAST MEDIUMS, RUST, MILL SCALE, PAINT PARTICLES AND DUST SHALL BE REMOVED FROM THE CONTAMINANT AREA AT LEAST ONCE PER DAY. THESE WASTES SHALL BE COLLECTED IN LEAK-PROOF CONTAINERS WHICH SHALL BE CLEARLY MARKED OF THE HAZARDS OF ITS CONTENTS, TARE WEIGHT OF THE CONTAINER, AND ORIGIN AND DATE OF THE MATERIAL COLLECTION WITH WEATHER RESISTANT LABELS. TRANSFER OF THIS MATERIAL FROM THE WORK AREA TO THE CONTAINERS AND THE STORAGE SITE FOR THE CONTAINERS SHALL BE SUCH THAT NO POLLUTION OF THE ENVIRONMENT WILL OCCUR AND WORKERS ARE FULLY PROTECTED. THE CONTAINERS SHALL BE TRANSPORTED TO A TEMPORARY STORAGE SITE IN ACCORDANCE WITH 40 CFR PART 263: "LAC 33.V." THE CONTRACTOR WILL BE RESPONSIBLE FOR OBTAINING THE TEMPORARY STORAGE SITE AT NO ADDITIONAL CHARGE TO THE DEPARTMENT. THIS SITE SHALL BE SECURE, PROVIDING PROTECTION FROM MIGRATION OF THE WASTE INTO THE ENVIRONMENT AND FROM VANDALISM AND PUBLIC ACCESS. WARNING SIGNS SHALL BE PROMINENTLY DISPLAYED AROUND THE PERIMETER OF THE SITE. THE WASTES MAY REMAIN AT THE TEMPORARY STORAGE SITE NO LONGER THAN NINETY (90) CALENDAR DAYS.

ALL WASTE STREAMS SHALL BE STORED IN SEPARATE CONTAINERS. THESE WASTE STREAMS SHALL BE SAMPLED AND TESTED IN ACCORDANCE WITH EPA METHOD 1311, "TOXICITY CHARACTERISTICS LEACHING PROCEDURE" (TCLP), TO DETERMINE THEIR CLASSIFICATION AND SHALL BE PROPERLY DISPOSED OF BASED ON THAT CLASSIFICATION.

ALL WASTE REGARDLESS OF REMOVAL METHOD SHALL BE PRESUMED TO BE HAZARDOUS UNTIL IT IS CLEARLY DEMONSTRATED BY APPROPRIATE SAMPLING AND TESTING TO BE NON-HAZARDOUS.

WASTES FOUND TO BE HAZARDOUS ARE SUBJECT TO THE PROVISIONS OF THE RCRA. TRANSPORTATION OF HAZARDOUS WASTES FOR TREATMENT AND DISPOSAL SHALL BE COMPLETELY MANIFESTED IN ACCORDANCE WITH 40 CFR PART 262: "LAC 33.V". A MANIFEST WILL BE REQUIRED FOR TRANSPORT OF BOTH HAZARDOUS AND NON-HAZARDOUS WASTE. THE MANIFEST SHALL BE RETURNED TO THE ENGINEER.

WASTES FOUND BY TESTING TO BE NON-HAZARDOUS MAY BE DISPOSED OF IN A SUBTITLE D (NON-HAZARDOUS) LANDFILL. SEE LAC 33.VII "SOLID WASTE REGULATIONS".

SPECIAL STENCILING:

THE DATE (MONTH AND YEAR) OF PAINTING AND TYPE OF PAINT SYSTEM USED SHALL BE STENCILED AT TWO (2) LOCATIONS DETERMINED BY THE ENGINEER ON ALL STRUCTURES IN BLOCK LETTERS 2-1/2 INCHES (63 MM) HIGH. THE PAINT USED SHALL FORM A CONTRAST WITH THE BACKGROUND AND SHALL BE COMPATIBLE WITH THE PAINT SYSTEM USED.

LACING BAR REMOVAL FOR ACCESS: REMOVAL AND RE-INSTALLATION OF LACING BARS, STAY PLATES AND OTHER STRUCTURAL ITEMS (AND REMOVAL AND REPLACEMENT OF ASSOCIATED RIVETS WITH HIGH-STRENGTH BOLTS) FOR ACCESS TO INTERIOR OF MEMBERS FOR CLEANING AND PAINTING PURPOSES ARE INCLUDED UNDER AND SHALL BE PAID AS PART OF PAY ITEM NS-800-0020, CLEANING, PAINTING, AND DISPOSAL (NEAR WHITE FINISH). ALL MEMBERS (TENSION AND COMPRESSION) SHALL HAVE TEMPORARY BRACING WHEN MORE THAN ONE SECTION OF LACING IS REMOVED. TEMPORARY BRACING METHODS FOR LACING REMOVAL SHALL BE ANALYZED AND SEALED BY A PROFESSIONAL ENGINEER LICENSED TO PRACTICE IN THE STATE OF LOUISIANA AND SUBMITTED TO THE PROJECT ENGINEER FOR APPROVAL.

ESTIMATED QUANTITIES FOR CLEANING AND PAINTING *

ITEM	SURFACE AREA (SQ. FT)			
	SHARED	HIGHWAY	RAILROAD	TOTAL
PHASE II EAST APPROACH	0	0	250,000	250,000
PHASE II WEST APPROACH	0	0	340,000	340,000

* FOR ESTIMATION PURPOSES ONLY

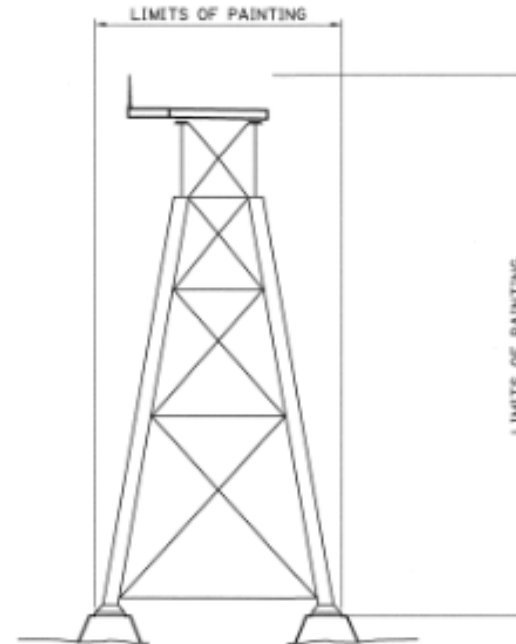

APPROACH SPAN TYPICAL CROSS SECTION
(N.T.S.)
(LOOKING WEST)

David A. Stone
10-24-2012

SHEET NUMBER	104	PROJECT	EAST & WEST BATON ROUGE	PROJECT NUMBER	H-009943
DESIGNED BY	CHECKED BY	DATE	SCALE	PROJECT	PROJECT
DAVID A. STONE	DAVID A. STONE	10/26/12	4 OF 10	EAST & WEST BATON ROUGE	EAST & WEST BATON ROUGE
GENERAL NOTES					
US 190 OVER THE MISSISSIPPI RIVER (PHASE II)					
					
					
					

35

STATE	FED. AID	CONTRACT	DATE	PROJECT	YEAR	SHEET	TOTAL
LA	100	100	1937	100	1937	100	100

STATE	FED. AID	CONTRACT	DATE	PROJECT	YEAR	SHEET	TOTAL
LA	100	100	1937	100	1937	100	100

3

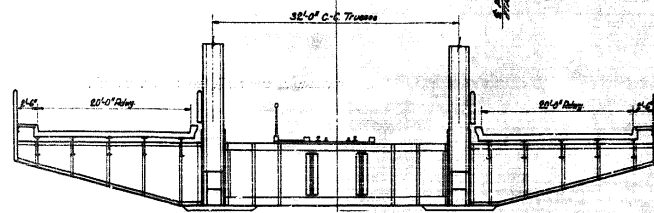
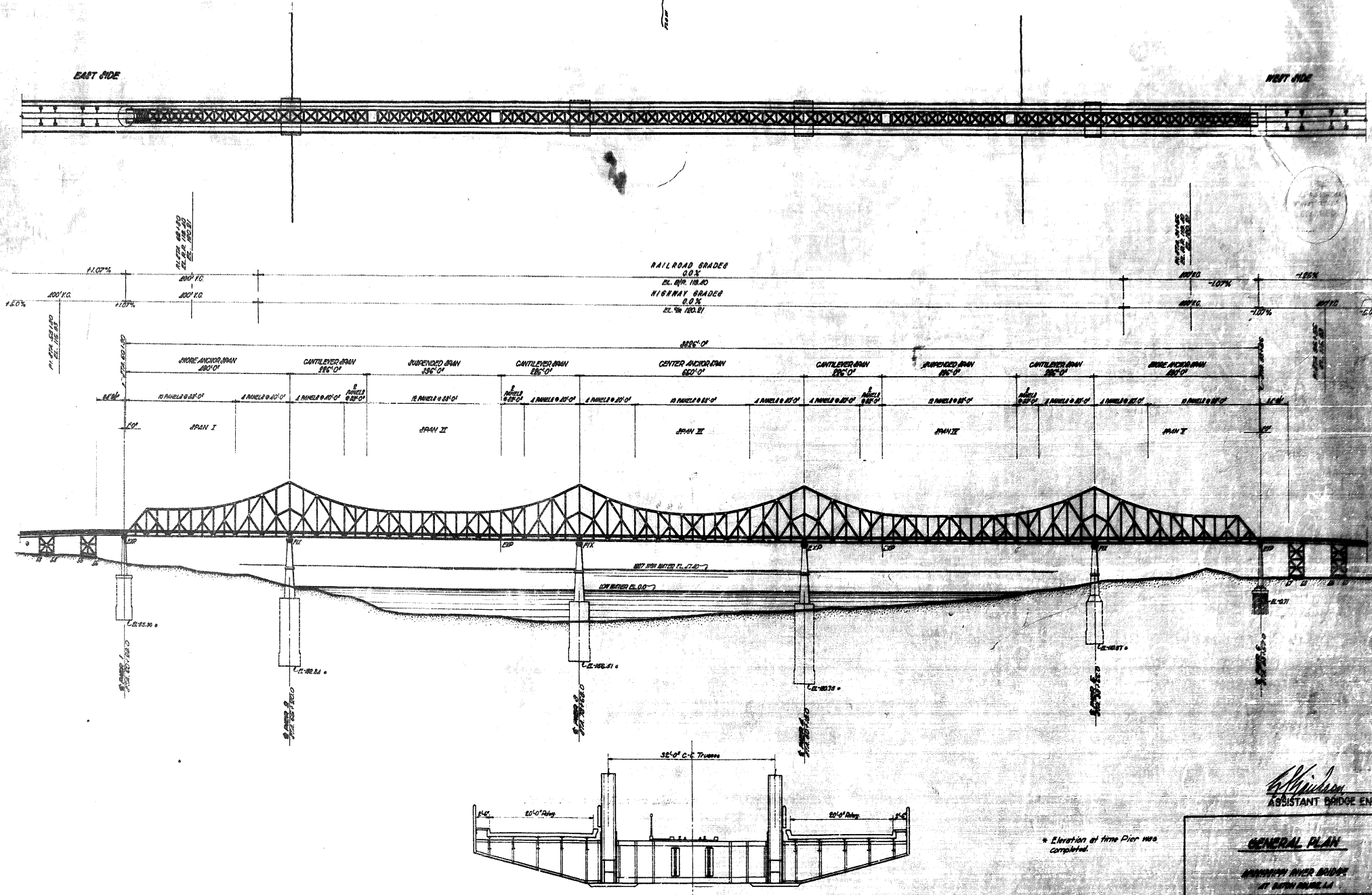

CROSS SECTION

W. H. Anderson
 ASSISTANT BRIDGE ENGR.

GENERAL PLAN

MISSISSIPPI RIVER BRIDGE
 AT BATON ROUGE, LA.

LOUISIANA HIGHWAY COMMISSION
 BATON ROUGE, LA. JAN 1937

NO.	DESCRIPTION	DATE	BY

47

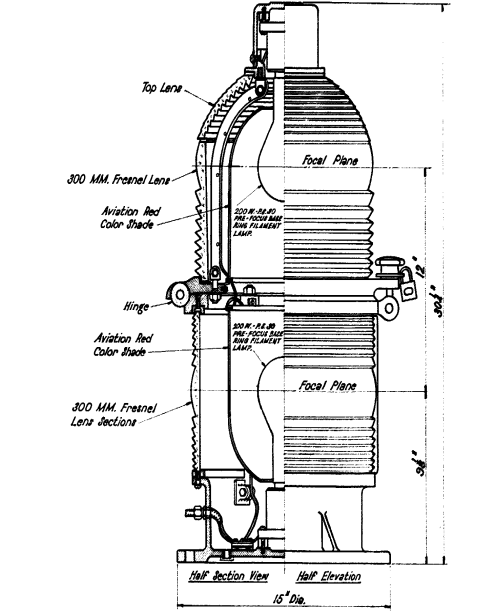
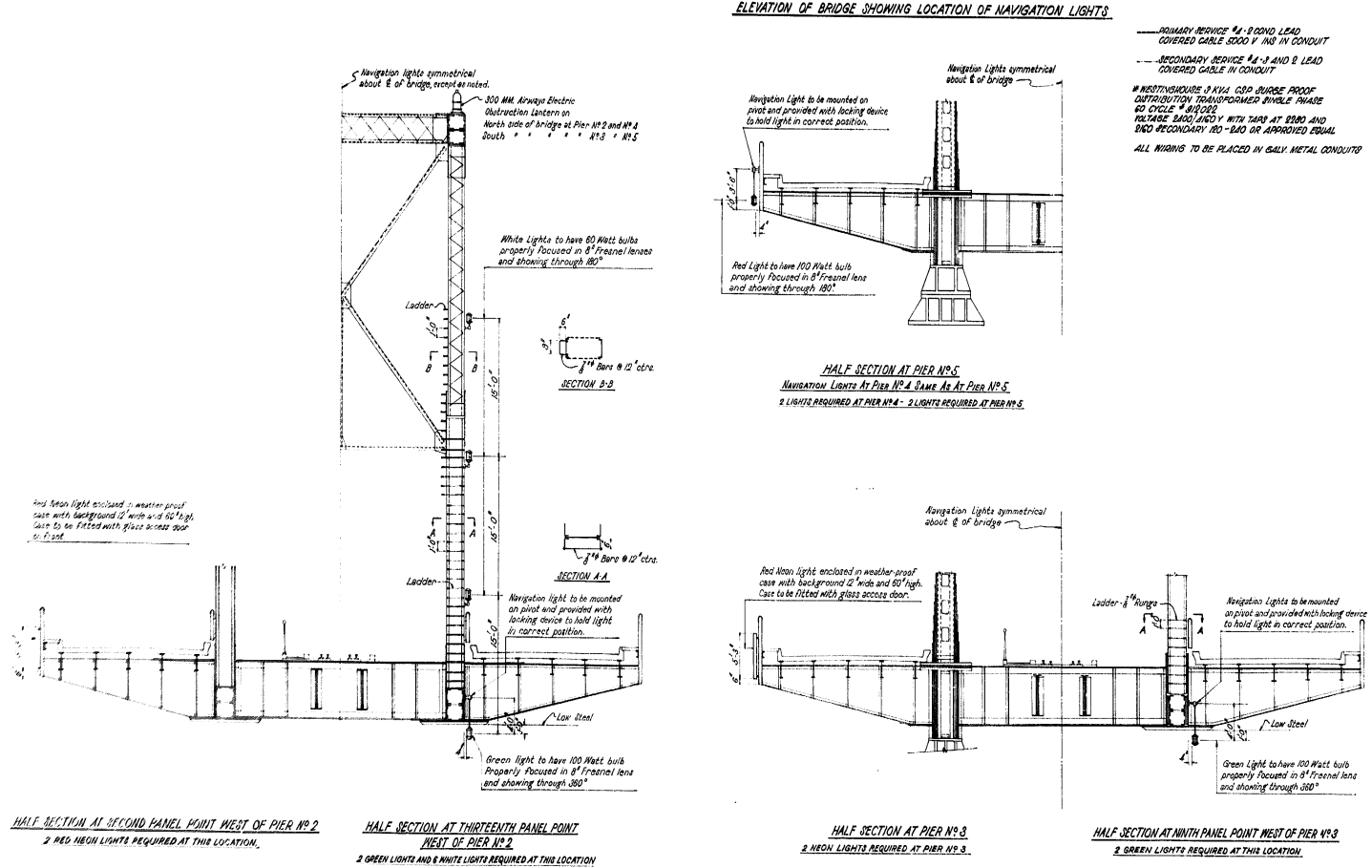
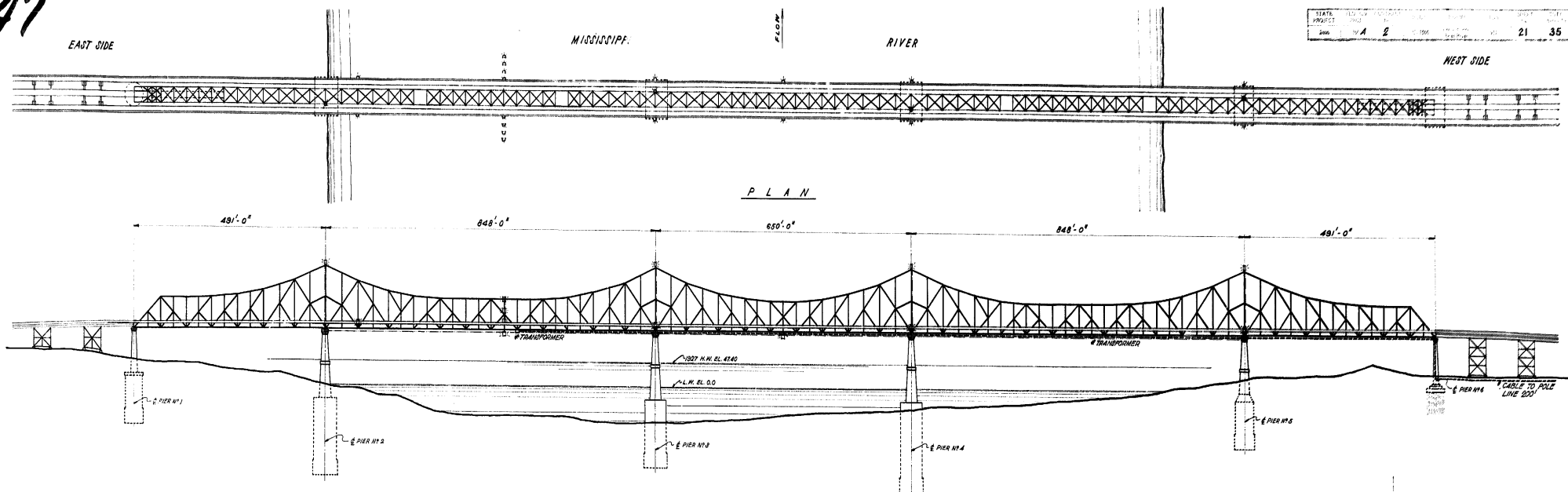

NAVIGATION LIGHTS
MISSISSIPPI RIVER BRIDGE
AT BATON ROUGE, LA.
LOUISIANA HIGHWAY COMMISSION
BATON ROUGE, LA. MARCH 1917

DESIGNED BY [Signature] TRACED [Signature]
 CHECKED BY [Signature] CHECKED [Signature]
 IN CHARGE OF [Signature] BRIDGE DESIGNING ENGINEER

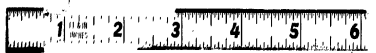

FINAL TRACINGS

THIS PAGE INTENTIONALLY LEFT BLANK

Appendix C. Maintenance Responsibility Exhibit

THIS PAGE INTENTIONALLY LEFT BLANK

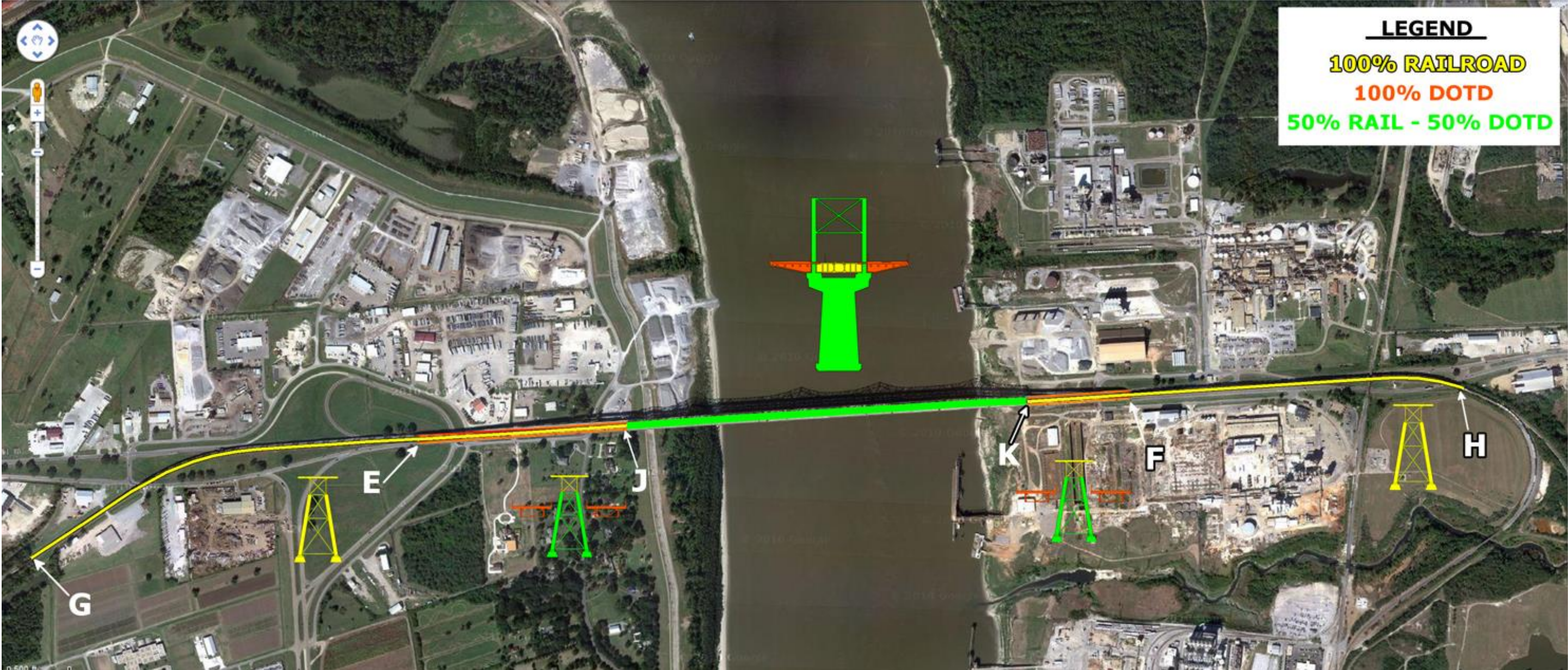

THIS PAGE INTENTIONALLY LEFT BLANK